



airCam
Security Camera

airVision™

QUICK START GUIDE

Introduction

Thank you for purchasing the airCam™. This Quick Start Guide is designed to guide you through the installation of the airCam and show you how to access the airCam's configuration interface. This Quick Start Guide also includes the warranty terms.

The airVision™ software and User Guide are available for download at downloads.ubnt.com/airvision.

The hardware installation process is different for indoor and outdoor installations. After familiarizing yourself with the airCam in the *Hardware Overview* section, please proceed to the appropriate installation section:

- "Outdoor Installation" on page 4
- "Indoor Installation" on page 8

Package Contents



Camera



Mounting Bracket



24V PoE Adapter



Power Cord



Seal

Self-Tapping
Screws (Qty. 3)Screw Anchors
(Qty. 3)

Quick Start Guide

Installation Requirements

- Pencil
- Drill and 6mm drill bits

TERMS OF USE: All Ethernet cabling runs must use CAT5 (or above). It is the customer's responsibility to follow local country regulations, including operation within legal frequency channels, output power, indoor cabling requirements, and Dynamic Frequency Selection (DFS) requirements.

Hardware Overview

Front

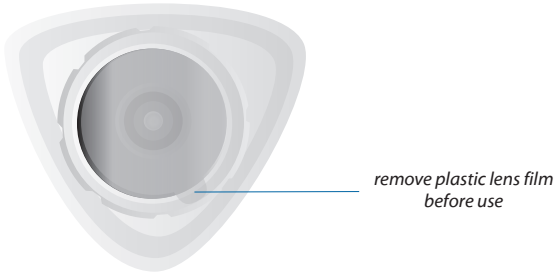
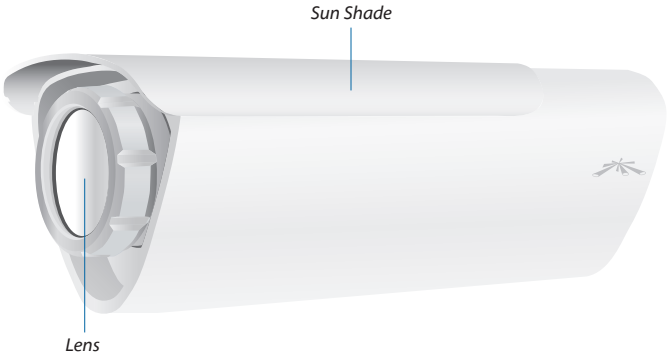

Back

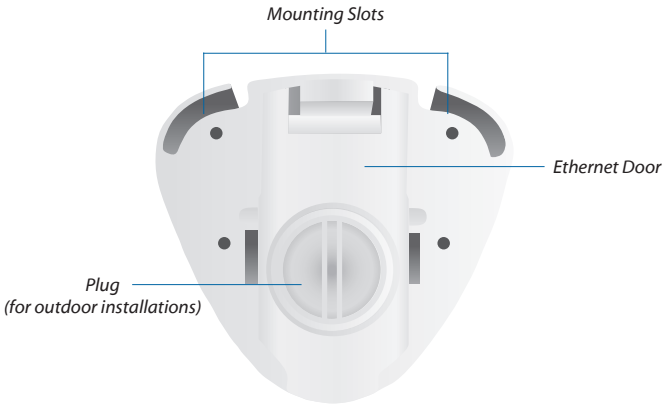

LEDs

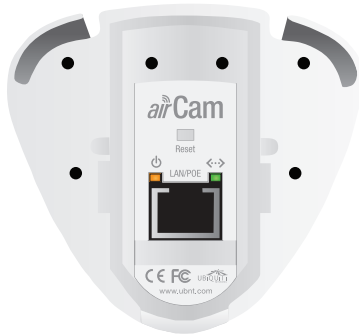

- ⏻ **Power** The Power LED will light steady orange when the airCam is connected to a power source.
- ↔ **Ethernet** The Ethernet LED will light steady green when an active Ethernet connection is made and flash when there is activity.

Installation Overview

The installation process is different depending on whether you are mounting the camera outdoors or indoors. Follow the instructions for the installation that you are performing.

Outdoor Installation



Important: The ideal outdoor location for mounting the airCam would be under an overhang/eave that shelters the camera. If the airCam is located in a completely open outdoor environment without an overhang/eave, do not install camera with a downtilt of more than 45°.

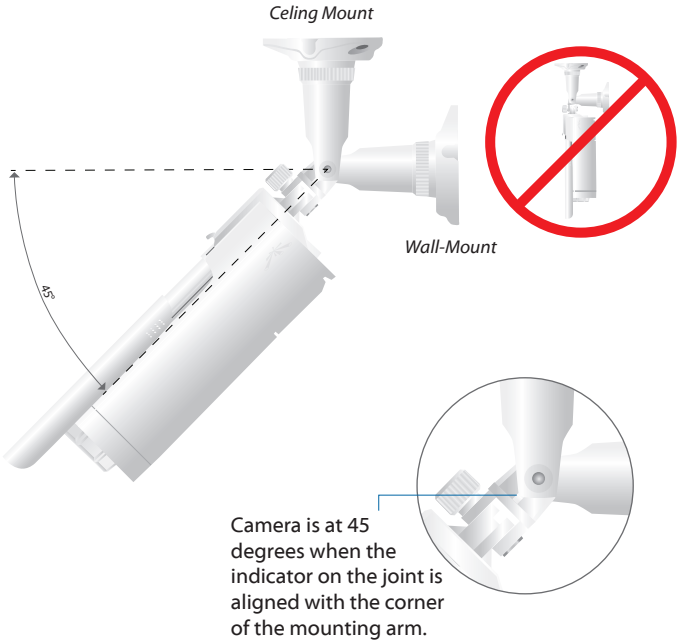

1. Press down on the release to remove the *Ethernet Door*.



Important: Do not remove the plug.



2. Connect the Ethernet cable to the Ethernet port.

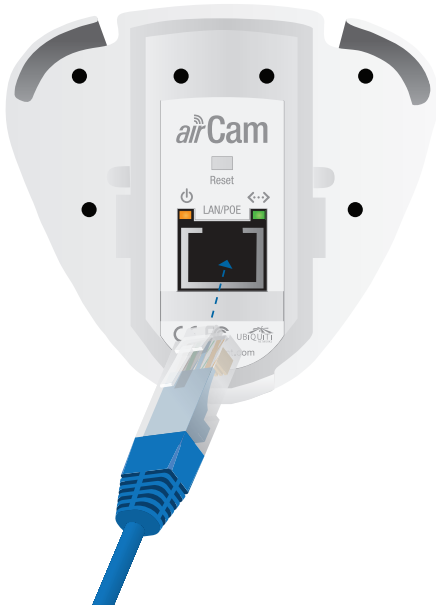

3. Insert the *Seal* into the bottom of the camera and wrap the *Seal* around the Ethernet cable. Reconnect the *Ethernet Door* to the airCam, leaving the Ethernet cable fed through the seal at the bottom of the camera.

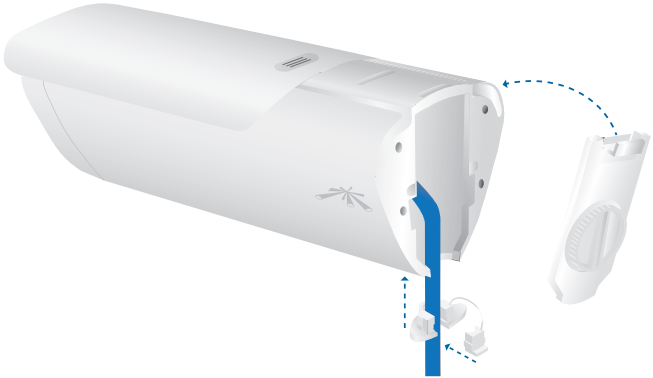

4. Insert the *Mounting Bracket* into the *Mounting Slots* until a click is heard to confirm a secure connection.

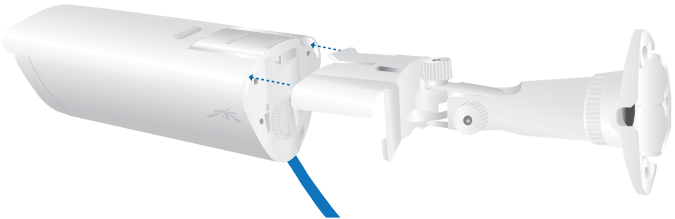

5. There are three recessed areas for the Ethernet cable on the *Mounting Bracket Base*. Thread the Ethernet cable through two of the recessed areas and out the one that will be closest to your power source.

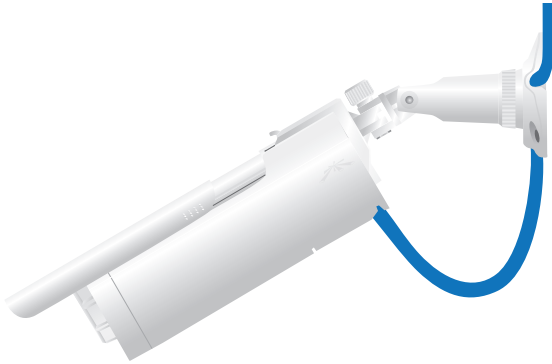

Important: If the power source is above the camera, extend the cable 70-80 mm below the camera body before routing up to the power source.

6. Position the *Mounting Bracket* in the desired location and use a pencil to mark the holes on the wall.
7. Use a 6 mm drill bit to drill the holes in the wall.
8. Insert a *Screw Anchor* into each hole.
9. Secure the *Mounting Bracket* to the wall using the *Self-Tapping Screws*.

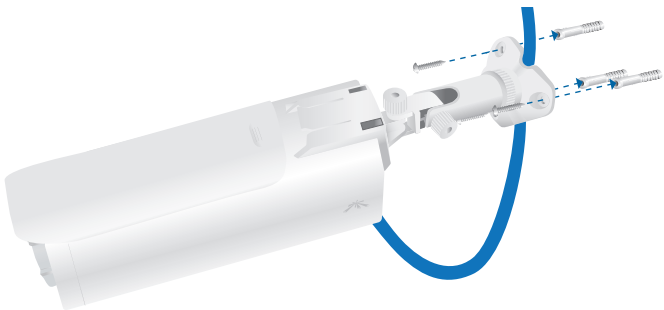

Indoor Installation

1. Remove the screw and knob that connect the *Mounting Bracket Base* to the camera attachment by turning the knob counter-clockwise.

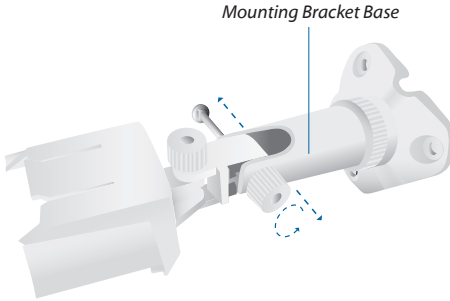

2. Insert an Ethernet cable through the *Mounting Bracket Base*.

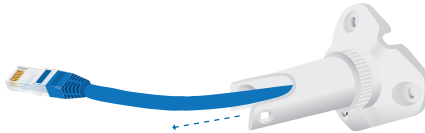

3. Reconnect the *Mounting Bracket Base* to the camera attachment by reconnecting the screw and knob. Turn the knob clockwise to lock the camera attachment back to the *Mounting Bracket Base*.



4. Unscrew the *Plug* on the back of the airCam.

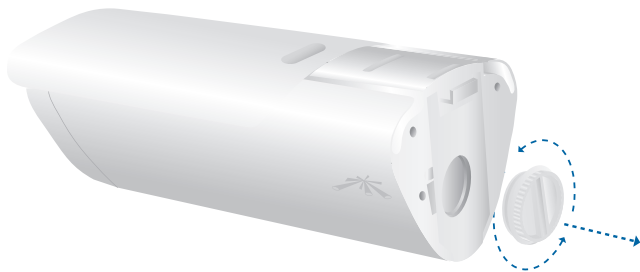

5. Connect the Ethernet cable to the Ethernet port.

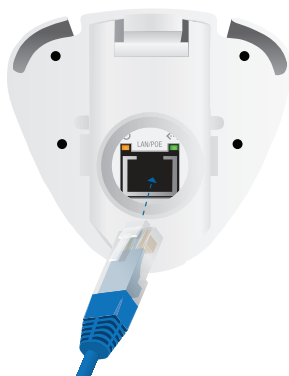

6. Insert the *Mounting Bracket* into the *Mounting Slots* until a click is heard to confirm a secure connection.

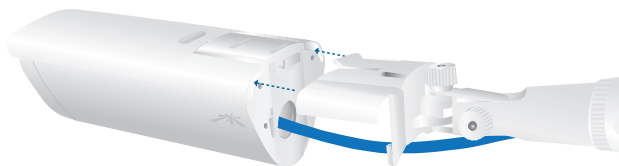

7. Position the *Mounting Bracket* in the desired location and use a pencil to mark the holes on the wall.
8. Use a 6 mm drill bit to drill the holes in the wall.
9. Insert the three *Screw Anchors* into the wall.
10. Secure the *Mounting Bracket* to the wall using the *Self-Tapping Screws*.

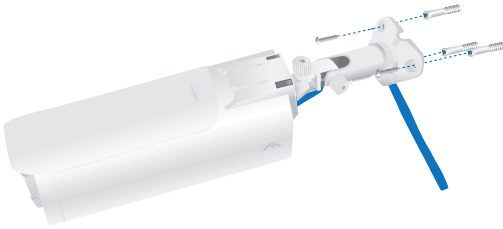

Note: There are three recessed areas for the Ethernet cable on the *Mounting Bracket Base*. Place the Ethernet cable in the recessed area that will be closest to your power source.

Connecting the Power

1. Connect the other end of the Ethernet cable to the Ethernet port labeled **POE** on the *PoE Adapter*.

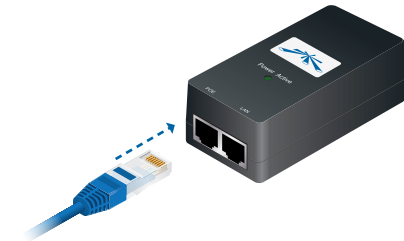

2. Connect an Ethernet cable from your LAN to the Ethernet port labeled **LAN** on the *PoE Adapter*.

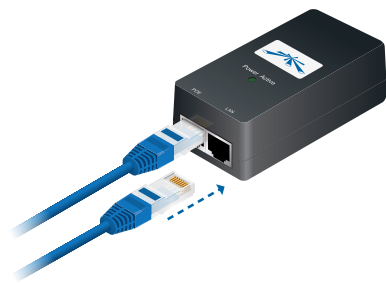

3. Connect the power cord to the power port on the *PoE Adapter*. Connect the other end of the power cord to a power outlet. The Power LED should light up on the airCam.

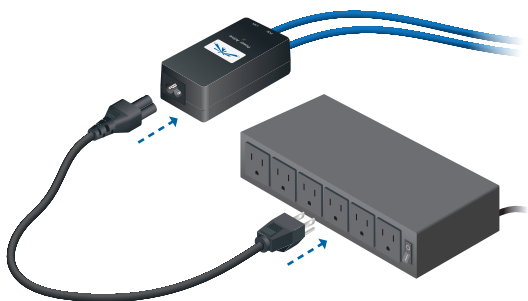

airVision

Download and install the latest version of the airVision software at downloads.ubnt.com/airvision; the airVision auto management feature should automatically detect and install your new camera.

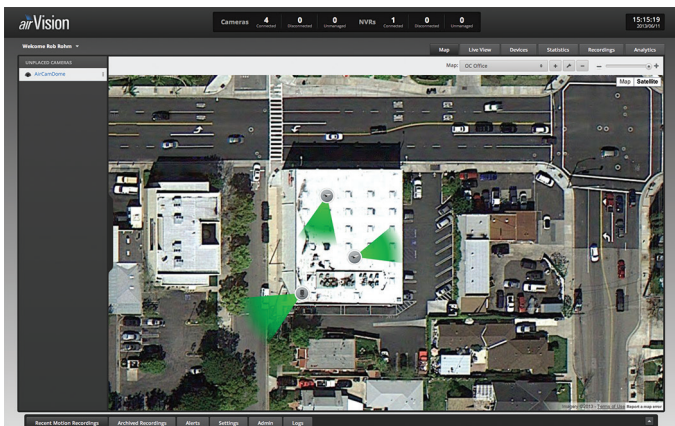

- Go to the airVision interface to verify the camera is installed. It should appear on the left under *Unplaced Cameras*.
- Drag the Camera 📷 to the appropriate location on the map.
- Click the Camera 📷 icon.
- Click the Live Feed 📺 icon and a live feed of the camera should be displayed.
- Skip to *Adjusting the Camera View* on page 15.

Camera Configuration Interface

Access the Camera Configuration Interface if you have not yet installed airVision, or plan to use the airCam as a stand-alone camera without airVision.

1. Make sure that your host machine is connected to the same LAN as the airCam.
2. The airCam is set to DHCP by default. If you have a router or DHCP server providing addresses on your network, please check your DHCP Client Table or download the Ubiquiti Discovery Tool from: <http://www.ubnt.com/download#app>



Note: If you do not have a DHCP server, the airCam defaults to the IP address **192.168.1.20**.

4. Launch your web browser and in the address field, type **http://** and then the IP address of the airCam, for example: **http://192.168.1.20**. Press **enter** (PC) or **return** (Mac).



5. The login screen will appear. Enter **ubnt** in the *Username* and *Password* fields and click **Login**.



6. The *Main* screen will appear and you should see a live video stream from the airCam.

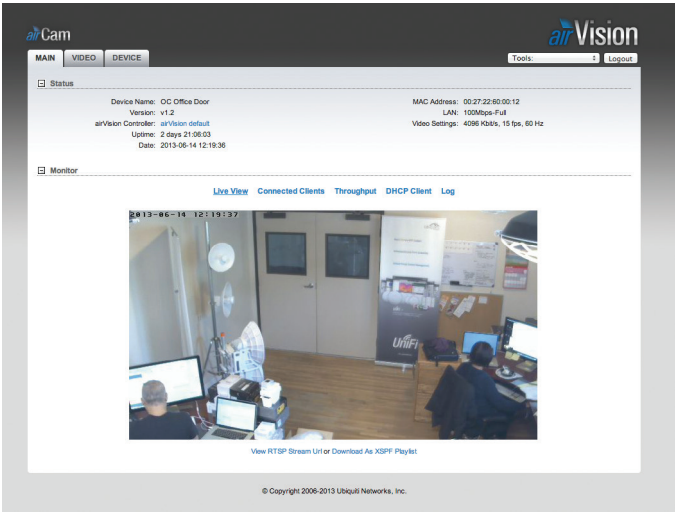

airCam airVision

MAIN VIDEO DEVICE Tools Logout

Status

Device Name: OC Office Door MAC Address: 00:27:22:60:00:12
 Version: v1.2 LAN: 100Mbps-Full
 airVision Controller: airVision default Video Settings: 4096 Kbits, 15 fps, 60 Hz
 Uptime: 2 days 21:08:03
 Date: 2013-06-14 12:19:36

Monitor

[Live View](#) [Connected Clients](#) [Throughput](#) [DHCP Client](#) [Log](#)

2013-06-14 12:19:37

[View RTSP Stream Url or Download As XSPF Playlist](#)

© Copyright 2006-2013 Ubiquiti Networks, Inc.



Note: If you need to change the airCam network settings (DHCP/Static), go to *Network Settings* on the *Device* tab.

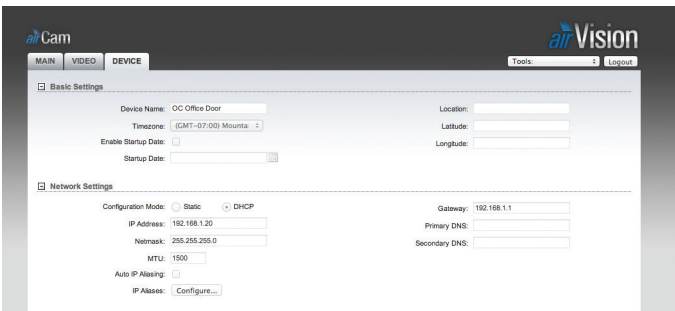

airCam airVision

MAIN VIDEO **DEVICE** Tools Logout

Basic Settings

Device Name: OC Office Door Location:
 Timezone: (GMT-07:00) Mountain Latitude:
 Enable Startup Date: Longitude:
 Startup Date:

Network Settings

Configuration Mode: Static DHCP Gateway: 192.168.1.1
 IP Address: 192.168.1.20 Primary DNS:
 Netmask: 255.255.255.0 Secondary DNS:
 MTU: 1500
 Auto IP Aliasing:
 IP Aliases: [Configure...](#)

Adjusting the Camera View

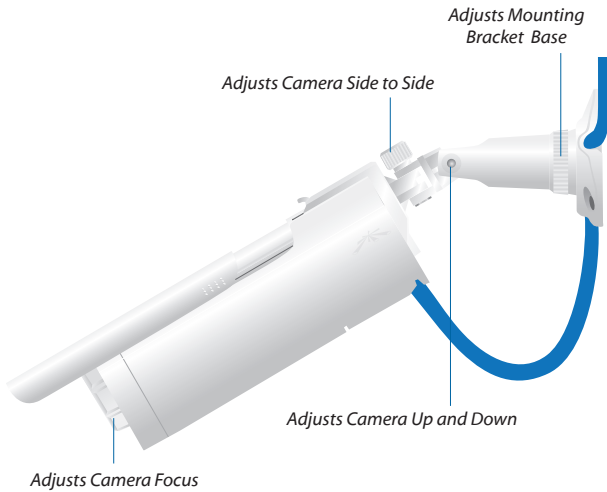

Hardware installation is complete. For details on using the airVision software or the Camera Configuration Interface, download the User Guide from downloads.ubnt.com/airvision

Limited Warranty

UBIQUITI NETWORKS, Inc (“UBIQUITI NETWORKS”) warrants that the product(s) furnished hereunder (the “Product(s)”) shall be free from defects in material and workmanship for a period of one (1) year from the date of shipment by UBIQUITI NETWORKS under normal use and operation. UBIQUITI NETWORKS’ sole and exclusive obligation and liability under the foregoing warranty shall be for UBIQUITI NETWORKS, at its discretion, to repair or replace any Product that fails to conform to the above warranty during the above warranty period. The expense of removal and reinstallation of any Product is not included in this warranty. The warranty period of any repaired or replaced Product shall not extend beyond its original term.

Warranty Conditions

The above warranty does not apply if the Product:

- (I) has been modified and/or altered, or an addition made thereto, except by Ubiquiti Networks, or Ubiquiti Networks’ authorized representatives, or as approved by Ubiquiti Networks in writing;
- (II) has been painted, rebranded or physically modified in any way;
- (III) has been damaged due to errors or defects in cabling;
- (IV) has been subjected to misuse, abuse, negligence, abnormal physical, electromagnetic or electrical stress, including lightning strikes, or accident;
- (V) has been damaged or impaired as a result of using third party firmware;
- (VI) has no original Ubiquiti MAC label, or is missing any other original Ubiquiti label(s); or
- (VII) has not been received by Ubiquiti within 30 days of issuance of the RMA.

In addition, the above warranty shall apply only if: the product has been properly installed and used at all times in accordance, and in all material respects, with the applicable Product documentation; all Ethernet cabling runs use CAT5 (or above), and for outdoor installations, shielded Ethernet cabling is used, and for indoor installations, indoor cabling requirements are followed.

Returns

No Products will be accepted for replacement or repair without obtaining a Return Materials Authorization (RMA) number from UBIQUITI NETWORKS during the warranty period, and the Products being received at UBIQUITI NETWORKS' facility freight prepaid in accordance with the RMA process of UBIQUITI NETWORKS. Products returned without an RMA number will not be processed and will be returned freight collect or subject to disposal. Information on the RMA process and obtaining an RMA number can be found at: www.ubnt.com/support/warranty.

Disclaimer

EXCEPT FOR ANY EXPRESS WARRANTIES PROVIDED HEREIN, UBIQUITI NETWORKS, ITS AFFILIATES, AND ITS AND THEIR THIRD PARTY DATA, SERVICE, SOFTWARE AND HARDWARE PROVIDERS HEREBY DISCLAIM AND MAKE NO OTHER REPRESENTATION OR WARRANTY OF ANY KIND, EXPRESS, IMPLIED OR STATUTORY, INCLUDING, BUT NOT LIMITED TO, REPRESENTATIONS, GUARANTEES, OR WARRANTIES OF MERCHANTABILITY, ACCURACY, QUALITY OF SERVICE OR RESULTS, AVAILABILITY, SATISFACTORY QUALITY, LACK OF VIRUSES, QUIET ENJOYMENT, FITNESS FOR A PARTICULAR PURPOSE AND NON-INFRINGEMENT AND ANY WARRANTIES ARISING FROM ANY COURSE OF DEALING, USAGE OR TRADE PRACTICE IN CONNECTION WITH SUCH PRODUCTS AND SERVICES. BUYER ACKNOWLEDGES THAT NEITHER UBIQUITI NETWORKS NOR ITS THIRD PARTY PROVIDERS CONTROL BUYER'S EQUIPMENT OR THE TRANSFER OF DATA OVER COMMUNICATIONS FACILITIES, INCLUDING THE INTERNET, AND THAT THE PRODUCTS AND SERVICES MAY BE SUBJECT TO LIMITATIONS, INTERRUPTIONS, DELAYS, CANCELLATIONS AND OTHER PROBLEMS INHERENT IN THE USE OF COMMUNICATIONS FACILITIES. UBIQUITI NETWORKS, ITS AFFILIATES AND ITS AND THEIR THIRD PARTY PROVIDERS ARE NOT RESPONSIBLE FOR ANY INTERRUPTIONS, DELAYS, CANCELLATIONS, DELIVERY FAILURES, DATA LOSS, CONTENT CORRUPTION, PACKET LOSS, OR OTHER DAMAGE RESULTING FROM ANY OF THE FOREGOING. In addition, UBIQUITI NETWORKS does not warrant that the operation of the Products will be error-free or that operation will be uninterrupted. In no event shall UBIQUITI NETWORKS be responsible for damages or claims of any nature or description relating to system performance, including coverage, buyer's selection of products (including the Products) for buyer's application and/or failure of products (including the Products) to meet government or regulatory requirements.

Limitation of Liability

EXCEPT TO THE EXTENT PROHIBITED BY LOCAL LAW, IN NO EVENT WILL UBIQUITI OR ITS SUBSIDIARIES, AFFILIATES OR SUPPLIERS BE LIABLE FOR DIRECT, SPECIAL, INCIDENTAL, CONSEQUENTIAL OR OTHER DAMAGES (INCLUDING LOST PROFIT, LOST DATA, OR DOWNTIME COSTS), ARISING OUT OF THE USE, INABILITY TO USE, OR THE RESULTS OF USE OF THE PRODUCT, WHETHER BASED IN WARRANTY, CONTRACT, TORT OR OTHER LEGAL THEORY, AND WHETHER OR NOT ADVISED OF THE POSSIBILITY OF SUCH DAMAGES.

Note

Some countries, states and provinces do not allow exclusions of implied warranties or conditions, so the above exclusion may not apply to you. You may have other rights that vary from country to country, state to state, or province to province. Some countries, states and provinces do not allow the exclusion or limitation of liability for incidental or consequential damages, so the above limitation may not apply to you. EXCEPT TO THE EXTENT ALLOWED BY LOCAL LAW, THESE WARRANTY TERMS DO NOT EXCLUDE, RESTRICT OR MODIFY, AND ARE IN ADDITION TO, THE MANDATORY STATUTORY RIGHTS APPLICABLE TO THE LICENSE OF ANY SOFTWARE (EMBEDDED IN THE PRODUCT) TO YOU. The United Nations Convention on Contracts for the International Sale of Goods shall not apply to any transactions regarding the sale of the Products.

Compliance

FCC

Changes or modifications not expressly approved by the party responsible for compliance could void the user's authority to operate the equipment.

This device complies with Part 15 of the FCC Rules. Operation is subject to the following two conditions:

1. This device may not cause harmful interference, and
2. This device must accept any interference received, including interference that may cause undesired operation.

NOTE: This equipment has been tested and found to comply with the limits for a Class A digital device, pursuant to part 15 of the FCC Rules. These limits are designed to provide reasonable protection against harmful interference when the equipment is operated in a commercial environment. This equipment generates, uses, and can radiate radio frequency energy and, if not installed and used in accordance with the instruction manual, may cause harmful interference to radio communications. Operations of this equipment in a residential area is likely to cause harmful interference in which case the user will be required to correct the interference at his own expense.

Industry Canada

This Class A digital apparatus complies with Canadian ICES-003.

Cet appareil numérique de la classe A est conforme à la norme NMB-003 du Canada.

CE Marking

CE marking on this product represents the product is in compliance with all directives that are applicable to it.



RoHS/WEEE Compliance Statement



English

European Directive 2002/96/EC requires that the equipment bearing this symbol on the product and/or its packaging must not be disposed of with unsorted municipal waste. The symbol indicates that this product should be disposed of separately from regular household waste streams. It is your responsibility to dispose of this and other electric and electronic equipment via designated collection facilities appointed by the government or local authorities. Correct disposal and recycling will help prevent potential negative consequences to the environment and human health. For more detailed information about the disposal of your old equipment, please contact your local authorities, waste disposal service, or the shop where you purchased the product.

Deutsch

Die Europäische Richtlinie 2002/96/EC verlangt, dass technische Ausrüstung, die direkt am Gerät und/oder an der Verpackung mit diesem Symbol versehen ist, nicht zusammen mit unsortiertem Gemeindeabfall entsorgt werden darf. Das Symbol weist darauf hin, dass das Produkt von regulärem Haushaltsmüll getrennt entsorgt werden sollte. Es liegt in Ihrer Verantwortung, dieses Gerät und andere elektrische und elektronische Geräte über die dafür zuständigen und von der Regierung oder örtlichen Behörden dazu bestimmten Sammelstellen zu entsorgen. Ordnungsgemäßes Entsorgen und Recyceln trägt dazu bei, potentielle negative Folgen für Umwelt und die menschliche Gesundheit zu vermeiden. Wenn Sie weitere Informationen zur Entsorgung Ihrer Altgeräte benötigen, wenden Sie sich bitte an die örtlichen Behörden oder städtischen Entsorgungsdienste oder an den Händler, bei dem Sie das Produkt erworben haben.

Español

La Directiva 2002/96/CE de la UE exige que los equipos que lleven este símbolo en el propio aparato y/o en su embalaje no deben eliminarse junto con otros residuos urbanos no seleccionados. El símbolo indica que el producto en cuestión debe separarse de los residuos domésticos convencionales con vistas a su eliminación. Es responsabilidad suya desechar este y cualesquiera otros aparatos eléctricos y electrónicos a través de los puntos de recogida que ponen a su disposición el gobierno y las autoridades locales. Al desechar y reciclar correctamente estos aparatos estará contribuyendo a evitar posibles consecuencias negativas para el medio ambiente y la salud de las personas. Si desea obtener información más detallada sobre la eliminación segura de su aparato usado, consulte a las autoridades locales, al servicio de recogida y eliminación de residuos de su zona o pregunte en la tienda donde adquirió el producto.

Français

La directive européenne 2002/96/CE exige que l'équipement sur lequel est apposé ce symbole sur le produit et/ou son emballage ne soit pas jeté avec les autres ordures ménagères. Ce symbole indique que le produit doit être éliminé dans un circuit distinct de celui pour les déchets des ménages. Il est de votre responsabilité de jeter ce matériel ainsi que tout autre matériel électrique ou électronique par les moyens de collecte indiqués par le gouvernement et les pouvoirs publics des collectivités territoriales. L'élimination et le recyclage en bonne et due forme ont pour but de lutter contre l'impact néfaste potentiel de ce type de produits sur l'environnement et la santé publique. Pour plus d'informations sur le mode d'élimination de votre ancien équipement, veuillez prendre contact avec les pouvoirs publics locaux, le service de traitement des déchets, ou l'endroit où vous avez acheté le produit.

Italiano

La direttiva europea 2002/96/EC richiede che le apparecchiature contrassegnate con questo simbolo sul prodotto e/o sull'imballaggio non siano smaltite insieme ai rifiuti urbani non differenziati. Il simbolo indica che questo prodotto non deve essere smaltito insieme ai normali rifiuti domestici. È responsabilità del proprietario smaltire sia questi prodotti sia le altre apparecchiature elettriche ed elettroniche mediante le specifiche strutture di raccolta indicate dal governo o dagli enti pubblici locali. Il corretto smaltimento ed il riciclaggio aiuteranno a prevenire conseguenze potenzialmente negative per l'ambiente e per la salute dell'essere umano. Per ricevere informazioni più dettagliate circa lo smaltimento delle vecchie apparecchiature in Vostro possesso, Vi invitiamo a contattare gli enti pubblici di competenza, il servizio di smaltimento rifiuti o il negozio nel quale avete acquistato il prodotto.

Declaration of Conformity

Česky [Czech]	UBIQUITI NETWORKS tímto prohlašuje, e tento UBIQUITI NETWORKS device, je ve shodě se základními požadavky a dále s ostatními ustanoveními směrnice 1999/5/ES.
Dansk [Danish]	Undertegnede UBIQUITI NETWORKS erklærer herved, at følgende udstyr UBIQUITI NETWORKS device, overholder de væsentlige krav og øvrige relevante krav i direktiv 1999/5/EF.
Nederlands [Dutch]	Hierbij verklaart UBIQUITI NETWORKS dat het toestel UBIQUITI NETWORKS device, in overeenstemming is met de essentiële eisen en de andere relevante bepalingen van richtlijn 1999/5/EG. Bij deze verklaart UBIQUITI NETWORKS dat deze UBIQUITI NETWORKS device, voldoet aan de essentiële eisen en aan de overige relevante bepalingen van Richtlijn 1999/5/EC.
English	Hereby, UBIQUITI NETWORKS, declares that this UBIQUITI NETWORKS device, is in compliance with the essential requirements and other relevant provisions of Directive 1999/5/EC.
Eesti [Estonian]	Käesolevaga kinnitab UBIQUITI NETWORKS seadme UBIQUITI NETWORKS device, vastavust direktiivi 1999/5/EÜ põhinõuetele ja nimetatud direktiivist tulenevatele teistele asjakohastele sätetele.
Suomi [Finnish]	UBIQUITI NETWORKS vakuuttaa täten että UBIQUITI NETWORKS device, tyypinen laite on direktiivin 1999/5/EY oleellisten vaatimusten ja sitä koskevien direktiivin muiden ehtojen mukainen.
Français [French]	Par la présente UBIQUITI NETWORKS déclare que l'appareil UBIQUITI NETWORKS, device est conforme aux exigences essentielles et aux autres dispositions pertinentes de la directive 1999/5/CE.
Deutsch [German]	Hiermit erklärt UBIQUITI NETWORKS, dass sich diese UBIQUITI NETWORKS device, in Übereinstimmung mit den grundlegenden Anforderungen und den anderen relevanten Vorschriften der Richtlinie 1999/5/EG befindet". (BMW)
Ελληνική [Greek]	ΜΕ ΤΗΝ ΠΑΡΟΥΣΑ UBIQUITI NETWORKS ΔΗΛΩΝΕΙ ΟΤΙ UBIQUITI NETWORKS device, ΣΥΜΜΟΡΦΩΝΕΤΑΙ ΠΡΟΣ ΤΙΣ ΟΥΣΙΩΔΕΙΣ ΑΠΑΙΤΗΣΕΙΣ ΚΑΙ ΤΙΣ ΛΟΙΠΕΣ ΣΧΕΤΙΚΕΣ ΔΙΑΤΑΞΕΙΣ ΤΗΣ ΟΔΗΓΙΑΣ 1995/5/ΕΚ.
Magyar [Hungarian]	Alulírott, UBIQUITI NETWORKS nyilatkozom, hogy a UBIQUITI NETWORKS device, megfelel a vonatkozó alapvető követelményeknek és az 1999/5/EC irányelv egyéb előírásainak.
Íslenska [Icelandic]	Hér með lýsir UBIQUITI NETWORKS yfir við a UBIQUITI NETWORKS device, er í samræmi við grunnkröfur og a rar kröfur, sem ger a eru í tilskipun 1999/5/EC.
Italiano [Italian]	Con la presente UBIQUITI NETWORKS dichiara che questo UBIQUITI NETWORKS device, è conforme ai requisiti essenziali ed alle altre disposizioni pertinenti stabilite dalla direttiva 1999/5/CE.

Latviski [Latvian]	Ar o UBIQUITI NETWORKS deklar , ka UBIQUITI NETWORKS device, atbilst Direkt vas 1999/5/EK b tiskaj m pras b m un citiem ar to saist tajiem noteikumiem.
Lietuviškai [Lithuanian]	UBIQUITI NETWORKS deklaruoja, kad šis UBIQUITI NETWORKS įrenginys atitinka esminius reikalavimus ir kitas 1999/5/EB Direktyvos nuostatas.
Malti [Maltese]	Hawnhekk, UBIQUITI NETWORKS, jiddikjara li dan UBIQUITI NETWORKS device, jikkonforma mal- ti ijjet essenzjali u ma provvedimenti o rajn rilevanti li hemm fid-Dirrettiva 1999/5/EC.
Norsk [Norwegian]	UBIQUITI NETWORKS erklærer herved at utstyret UBIQUITI NETWORKS device, er i samsvar med de grunnleggende krav og øvrige relevante krav i direktiv 1999/5/EF.
Slovensky [Slovak]	UBIQUITI NETWORKS t mto vyhlasuje, e UBIQUITI NETWORKS device, sp a základné po iadavky a v etky príslu né ustanovenia Smernice 1999/5/ES.
Svenska [Swedish]	Härmed intygar UBIQUITI NETWORKS att denna UBIQUITI NETWORKS device, står i överensstämmelse med de väsentliga egenskapskrav och övriga relevanta bestämmelser som framgår av direktiv 1999/5/EG.
Español [Spanish]	Por medio de la presente UBIQUITI NETWORKS declara que el UBIQUITI NETWORKS device, cumple con los requisitos esenciales y cualesquiera otras disposiciones aplicables o exigibles de la Directiva 1999/5/CE.
Polski [Polish]	Niniejszym, firma UBIQUITI NETWORKS o wiadcza, e produkt serii UBIQUITI NETWORKS device, spełnia zasadnicze wymagania i inne istotne postanowienia Dyrektywy 1999/5/EC.
Português [Portuguese]	UBIQUITI NETWORKS declara que este UBIQUITI NETWORKS device, está conforme com os requisitos essenciais e outras disposições da Directiva 1999/5/CE.
Română [Romanian]	Prin prezenta, UBIQUITI NETWORKS declară că acest dispozitiv UBIQUITI NETWORKS este în conformitate cu cerințele esențiale și alte prevederi relevante ale Directivei 1999/5/CE.

TOUGHSwitch™ PoE

The Advanced Gigabit PoE Managed Switch from Ubiquiti Networks

Power your Ubiquiti devices with TOUGHSwitch™ PoE. TOUGHSwitch PoE delivers reliable power and fast Gigabit connectivity to devices that support passive Power over Ethernet.



Simplify Your Deployment

TOUGHSwitch PoE deployments increase efficiency and greatly reduce the number of potential failure points, resulting in faster installations and less maintenance and troubleshooting. TOUGHSwitch PoE allows network architects to design cleaner, less cluttered deployments.

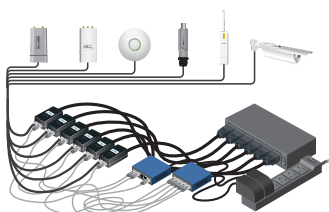

Before TOUGHSwitch PoE

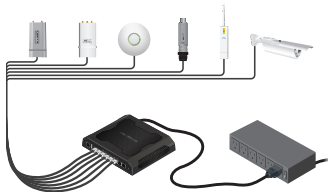

After TOUGHSwitch PoE

Available Models



TS-5-POE
5 Gigabit Ports, 24V PoE



TS-5-PRO
8 Gigabit Ports, 24V or 48V PoE



TS-16-CARRIER
16 Gigabit Ports, 24V or 48V PoE, Rack-Mountable

Support **support.ubnt.com**
Community **community.ubnt.com**
Downloads **downloads.ubnt.com**

