





SAFETY SECTION

Contents

SAFETY01-10	1. General Safety Precautions
SAFETY01-10	1.1 Before starting maintenance
SAFETY01-20	1.2 General Precaution during work
SAFETY01-20	1.2.1 Precaution during work
SAFETY01-30	1.2.2 Preventing being caught by rotating or moving parts
SAFETY01-31	1.2.3 Cautionary notes on works for a machine with the power turned on
SAFETY01-40	1.3 Prevention of electric shocks
SAFETY01-60	1.4 Procedures in an emergency
SAFETY01-60	1.4.1 For electric shock
SAFETY01-70	1.4.2 For outbreak of fire
SAFETY02-10	2. UNIT EMERGENCY POWER OFF switch
SAFETY03-10	3. Hazard Warning Statements
SAFETY03-10	3.1 DANGER Statements
SAFETY03-20	3.2 WARNING Statements
SAFETY03-30	3.3 CAUTION Statements
SAFETY04-10	4. Attachment Position of Safety Labels

 **SAFETY SUMMARY**

The hazard warnings which appear on the warning labels on the machine or in the manual have one of the following alert headings consisting of an alert symbol and a signal word, DANGER, WARNING, or CAUTION.

	This is the safety alert symbol. It is used to alert you to potential personal injury hazards. Obey all safety messages that follow this symbol to avoid possible injury or death.
 DANGER:	Indicates an imminently hazardous situation which, if not avoided, will result in death or serious injury.
 WARNING:	Indicates a potentially hazardous situation which, if not avoided, can result in death or serious injury.
 CAUTION:	Indicates a potentially hazardous situation which, if not avoided, may result in minor or moderate injury.
CAUTION:	Indicates a potentially hazardous situation which, if not avoided, may result in property damage.

The signal word 'NOTICE' is used to present warnings which are not directly related to personal injury hazards.

**SAFETY SUMMARY**

1. General Safety Precautions

Read the following safety guidelines carefully and follow them when you conduct maintenance of the machine.

1.1 Before starting maintenance

- Maintenance of the machine must be done only by trained and qualified field engineers.
- Read and follow the safety guidelines and procedures in this manual and the related manuals.
- In this manual and on the machine, hazard warnings are provided to aid you in preventing or reducing the risk of death, personal injury, or product damage.
Understand and follow these hazard warnings fully.
- When warning labels become dirty or start peeling off, replace them.
- If any physical accident such as abnormal noise, smell, smoke or falling down occurs on the Disk Subsystem while running, immediately power off the Disk Subsystem by pulling the UNIT EMERGENCY POWER OFF switch on the Disk Subsystem.
- Keep in mind that the hazard warnings in this manual or on the machine cannot cover every possible case, as it is impossible to predict and evaluate all circumstances before hand.
Be alert and use your common sense.
- About the handling of the battery for timers built in SVP.

CAUTION
RISK OF EXPLOSION IF BATTERY IS REPLACED
BY AN INCORRECT TYPE.
DISPOSE OF USED BATTERIES ACCORDING
TO THE INSTRUCTIONS.

**SAFETY SUMMARY (Continued)**

1.2 General Precaution during work**1.2.1 Precaution during work**

- For each procedure, follow the given sequence of steps.
- Use the spare parts, consumable and materials for maintenance which are specified in the manual; otherwise, personal injury or damage of the machine, as well as deterioration of the product's quality, may result.
- Use the special tools and instruments specified for the work in the manual or commercially available tools and instruments which fit the purpose.
- Use measurement instruments and powered tools which are properly calibrated or periodically inspected.
- Keep the maintenance area neat and tidy.
- Always put away parts, materials or tools when not in use.
- Wear an eye protector where liquid may splash or anything may fly about.
- When lifting anything heavy, hold it close to yourself and keep your back erect, to prevent injury to your back or spine.
When lifting anything, for the weight of which CAUTION is indicated, use a proper lifting tool or have somebody help you.
- Keep a soldering iron and its stand away from you to prevent accidental contact and burns.
- When using sharp objects or cutting tools, make sure that no part of your body lies in the path of the blade bit, or point.
- Before finishing you work, make sure that all parts removed during maintenance have been installed back in their original positions in the machine.
Make sure that no tool or foreign material is left in the machine.

**SAFETY SUMMARY (Continued)**

1.2.2 Preventing being caught by rotating or moving parts

- Tuck in your tie, scarf, shirt, or any other loose clothing so that it will not be caught by a rotating or moving part.
- Tie up long hair.
- Unless otherwise specifically instructed, do not supply power to any device with rotating or moving parts which are not properly covered.
- When instructed to supply power to any device with rotating or moving parts whose covers have been removed, work with another person who can immediately turn off the power in an emergency.

**SAFETY SUMMARY (Continued)**

1.2.3 Cautionary notes on works for a machine with the power turned on

The works concerned are those to be done for the subsystem while the subsystem power is turned on.

- When you do the work, fully take care not to touch live electric parts so that you should not get an electric shock.
- Take enough care not to touch heat sinks immediately after a PCB is pulled out because they are very hot.
- While doing the work, take care not to drop a tool, a screw, or the like that can cause a short circuit.
- While doing the work, take care not to damage a wire or have it pinched.
- Take care not to put your finger in a rotating fan blades or not to have your hair (when it is long), tie, scarf, shirt, or the like caught by the blades.
- When moving anything heavy, be sure to do the moving by two persons after making sure that there is no obstacle around you, and take enough care not to cause an electric shock or short circuit by touching / dropping it to / on a live electric circuit.
- When doing the work leaving the SVP or swinging gate open, take care not to hit your head against it as well as not to get an electric shock.



SAFETY SUMMARY (Continued)

1.3 Prevention of electric shocks

- Before starting work, make sure that, unless otherwise specifically instructed, there is no potential electric hazard in the maintenance area such as insufficient grounding or a wet floor.
- Before starting work, note where the UNIT EMERGENCY POWER OFF switches are located and make sure you know how to operate them.
- Unless otherwise specifically instructed, cut off all power sources to the machine before stating maintenance. Just switching off the machine power supplies is usually not enough. When power is fed from a wall or floor outlet, unplug the power supply cord, or turn off the switch on the power distribution panel or board.

Attach a notice on the panel or board prohibiting the use of the switch.

If the energy isolating device (*1) such as the switch on the power distribution panel or board accepts a lockout device (*1), turn off the power, lock out the energy isolating device, and bring the key with you.

When you take over the work and the key for the lockout device if applicable, do not assume that the power is off. Make sure yourself that the above-mentioned conditions such as switches are satisfied. IF necessary, use a measurement tool to ensure that the power is off.

(*1) The following is a portion of 29 CFR 1910.147 “The control of hazardous energy (lockout / tagout),” in the OSHA (Occupational Safety & Health Administration U.S. Department of Labor USA) Regulations.

- Energy isolating device. A mechanical device that physically prevents the transmission or release of energy, including but not limited to the following: A manually operated electrical circuit breaker; a disconnect switch; a manually operated switch by which the conductors of a circuit can be disconnected from all ungrounded supply conductors, and, in addition, no pole can be operated independently; a line valve; a block; and any similar device used to block or isolate energy. Push buttons, selector switches and other control circuit type devices are not energy isolating devices.
- Lockout device. A device that utilizes a positive means such as a lock, either key or combination type, to hold an energy isolating device in a safe position and prevent the energizing of a machine or equipment. Included are blank flanges and bolted slip blinds.

**SAFETY SUMMARY (Continued)**

- Do not touch any uninsulated conductor or surface, where so instructed, which remains charged for a limited time after the external power supply to the machine is disconnected.
- When working on a machine which has a grounding terminal, make sure that the terminal is properly connected to the facility's ground.
- When working close to a hazardously energized part, do not work alone; work with another person who can immediately turn off the power in an emergency.
- Do not wear any metallic item such as a wrist watch with a metallic surface, or metallic accessories.

If you wear eyeglasses with a metallic frame, take care not to let the frame touch an uninsulated surface.

- Make sure that your hands and arms are dry.
 - Unless otherwise specifically instructed, use only one hand when it is necessary to work near an exposed live electric circuit.
This prevents the completion of the circuit through both hands even if you accidentally touch the circuit.
 - Do not use a dental mirror near an exposed live electric circuit.
The mirror surface is conductive and can become hazardous even if it is made of plastic.
 - Unless otherwise specifically instructed, do not supply power to any subassembly such as a power supply unit or a motor while it is removed from the machine.
 - Do not perform telephone line construction in thunderstorm.
-

**SAFETY SUMMARY (Continued)**

1.4 Procedures in an emergency**1.4.1 For electric shock**

- Do not be panicked. Do not become another victim through contact with the injured person.
- First, shut off the electric current passing through the victim.
Use the emergency power-off switch if there is one, or otherwise a normal power-off switch.
If this cannot be done, push the victim away from the source of the electric current by using a nonconductive object such as a dry wooden stick.
- Then, call an ambulance.
- If the victim is unconscious, artificial respiration may be necessary.
A proper method for performing artificial respiration or resuscitation should be learned beforehand.
- If the victim's heart is not beating, cardio-pulmonary resuscitation should be performed by a trained and qualified person.

**SAFETY SUMMARY (Continued)**

1.4.2 For outbreak of fire

- First, shut off all the power from the machine using the emergency power-off switch if there is one, or otherwise the normal power-off switch.
- If the fire continues burning after the power is shut off, take suitable actions including the use of a fire extinguisher or a call for the fire department.

⚠ SAFETY SUMMARY (Continued)

2. UNIT EMERGENCY POWER OFF switch

A UNIT EMERGENCY POWER OFF switch is provided on the rear upside of the DKC for an emergency powering off. When any abnormality such as an abnormal sound or smell or emitting smoke is perceived, power off the disk subsystem by operating the switch following the procedure below. The procedure for operating the switch is as follows.

For recovery of EPO switch, refer to page [SAFETY02-20](#).

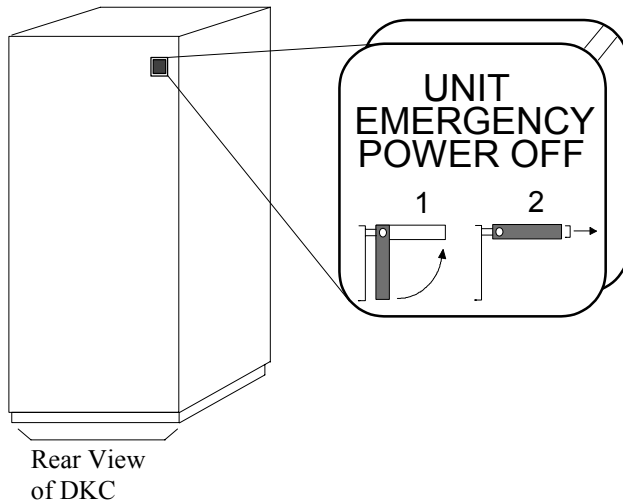

Fig. 2-1 Operation of UNIT EMERGENCY POWER OFF switch

- In using a UNIT EMERGENCY POWER OFF switch, first pull it up and then pull it toward you as illustrated.
- Pulling a UNIT EMERGENCY POWER OFF switch on the Disk Controller instantly shuts down, neglecting the systems power off sequence. Jobs in process are aborted and their integrity after recovery is not guaranteed. Therefore, this method should be used only in an emergency and not in usual maintenance.
- UNIT EMERGENCY POWER OFF switch on the Disk Controller only provide partial power off capability, and AC input power present at primary circuit yet. Therefore, do not use the switches on these units unless powering off of the own unit is obviously enough and safe as an emergency measure.
- When pulled, a UNIT EMERGENCY POWER OFF switch locks itself to prevent further powering on and requires a trained and qualified field engineer for recovery.

 SAFETY SUMMARY (Continued)

Recovery of EPO switch

- (1) Remove the EPO switch.
(See [REP03-300 to REP03-320](#) in the REPLACE SECTION.)
- (2-a) Push down (PUSH-A) the spring mounted in the removed EPO switch. (See Fig.2-2)
- (2-b) Then push (PUSH-B) the plunger into the EPO switch. (See Fig.2-2)
- (3) Attach the EPO switch.
(See [REP03-300 to REP03-320](#) in the REPLACE SECTION.)

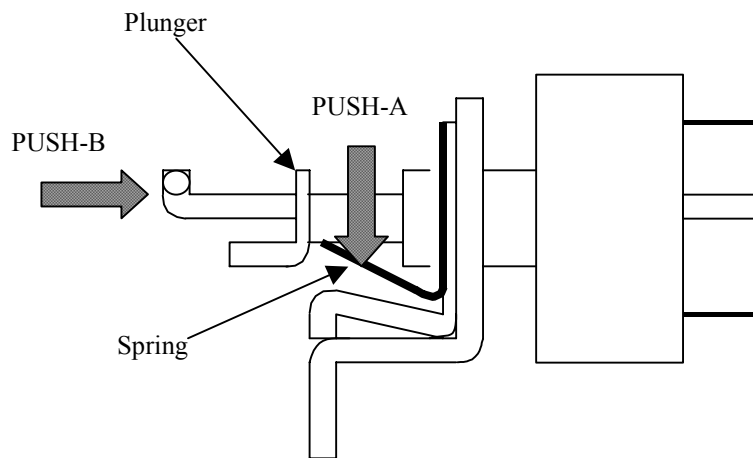

Fig. 2-2 Emergency condition

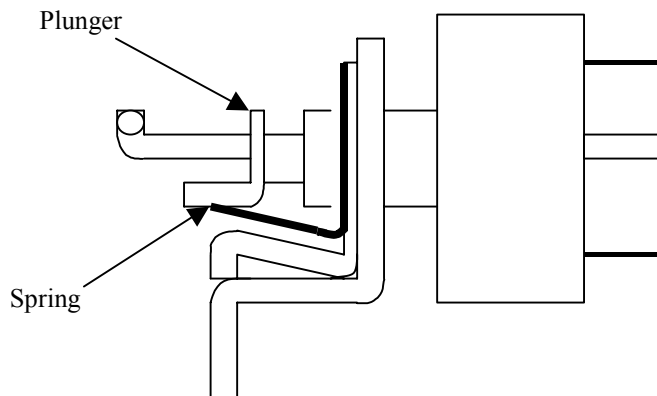

Fig. 2-3 Normal condition

**SAFETY SUMMARY (Continued)**

3. Hazard Warning Statements

The following are the hazard warning statements contained in this manual.

3.1 DANGER Statements

None

**SAFETY SUMMARY (Continued)**

3.2 WARNING Statements

Hazardous voltage:

Contact could cause electric shock or burn. Turn off all related breakers and discharge residual voltage, as shown below (Follow next procedures).

([REP03-860](#), [REP03-940](#), [REP03-1020](#), [REP03-1090](#), [REP03-1160](#), [REP03-1230](#))

Hazardous voltage:

Contact could cause electric shock or burn. Turning off the breaker on the distribution board connected to the AC BOX before start your work.

([REP03-870](#), [REP03-950](#), [REP03-1030](#), [REP03-1100](#), [REP03-1170](#), [REP03-1240](#))

**SAFETY SUMMARY (Continued)****3.3  CAUTION Statements**

Hazardous voltage:

Contact could cause electric shock or burn. Do not touch the internal parts of the AC power cable or the AC Box. Line voltage is present even if the circuit breaker is off.

([INST03-04-280](#), [INST03-13-10](#))

Hazardous rotating mechanism:

Can cause injury if touched. Stay clear of it when machine is running.

([REP03-470](#))

Paying attention to falls: The weight of the battery box is 7 kg.

If the battery box falls, injury may occur. Hold the battery box firmly by both hands and use caution to prevent it from falling.

([REP03-600](#))

Watching for short-circuits: A Short-circuit may cause a fire.

Never insert metal or the like into the battery box connector or a short-circuit may occur.

([REP03-600](#))

Watching for short-circuits: A Short-circuit may cause a fire. Never insert metal or the like into the cable connector or a short-circuit may occur.

([REP03-650](#), [REP03-790](#))

SAFETY SUMMARY (Continued)

4. Attachment Position of Safety Labels

The attachment position of the safety labels is shown below.

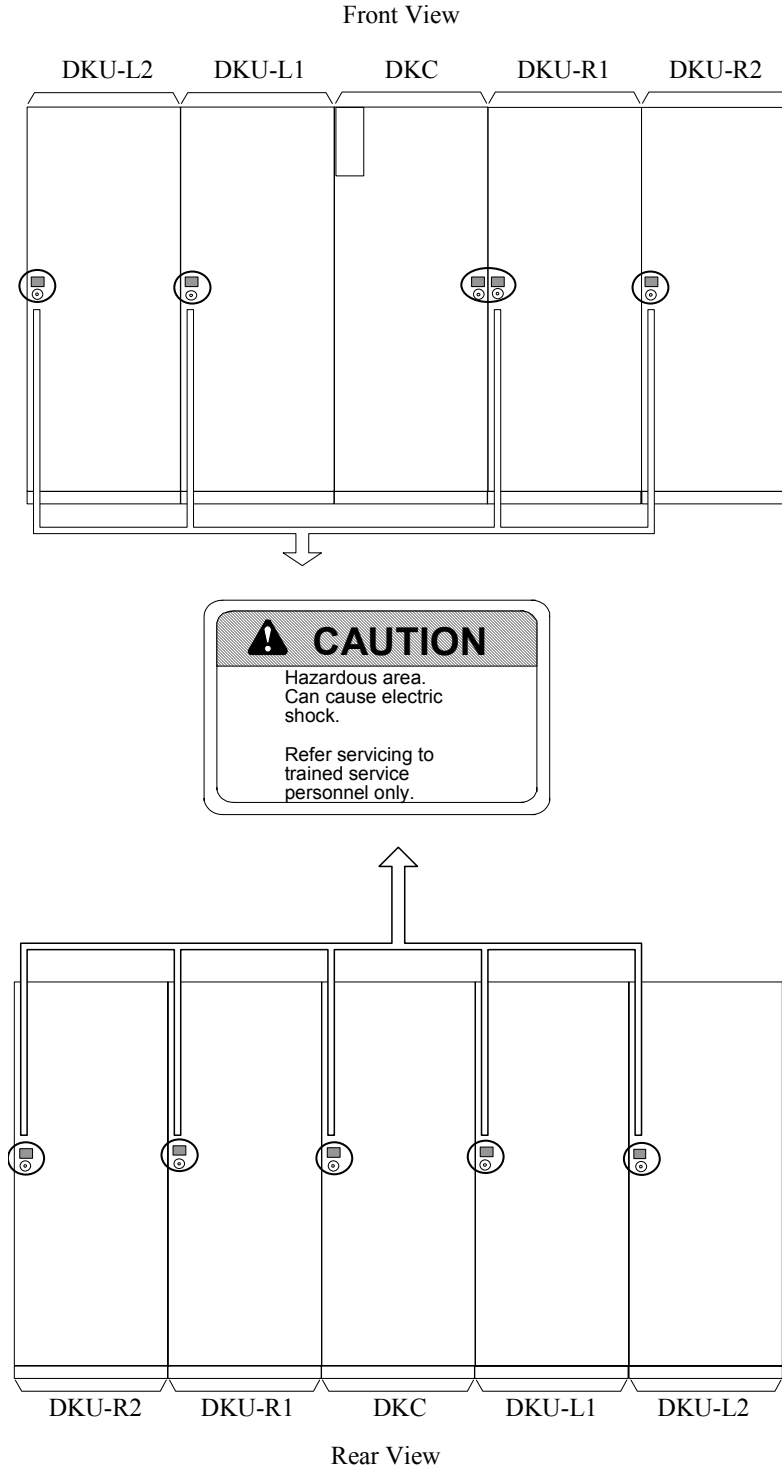

Fig.4-1 Attachment Position of Safety Labels

SAFETY SUMMARY (Continued)

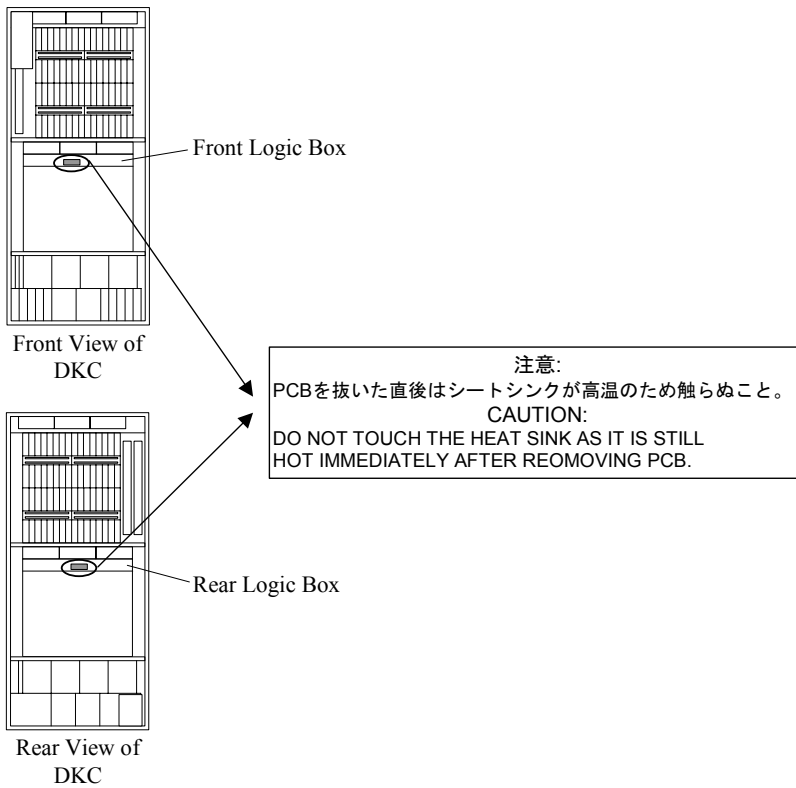
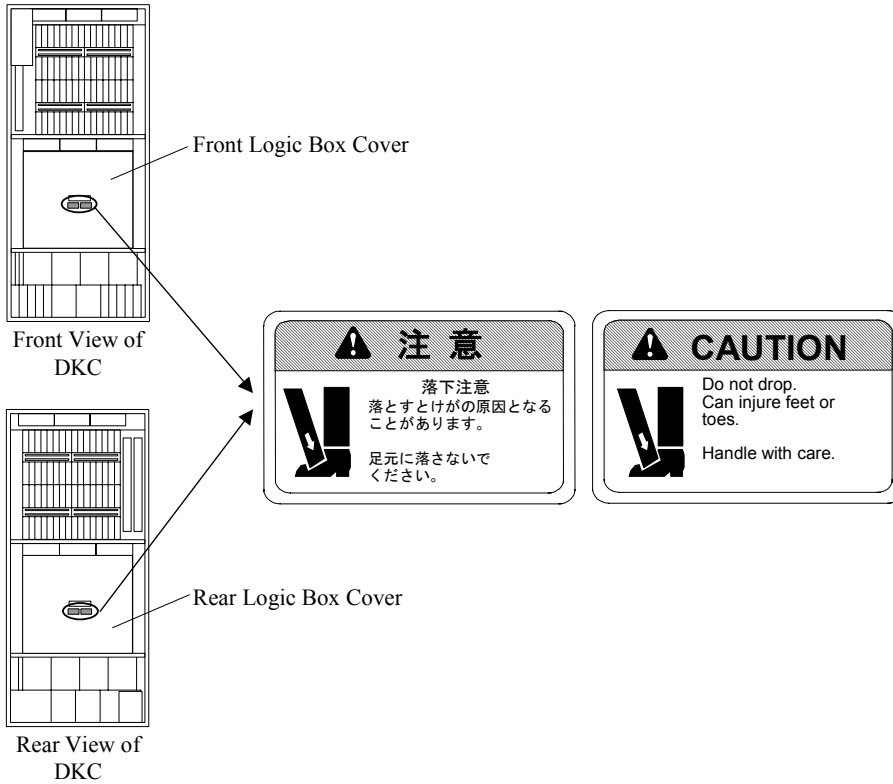

Fig.4-2 Attachment Position of Safety Labels

SAFETY SUMMARY (Continued)

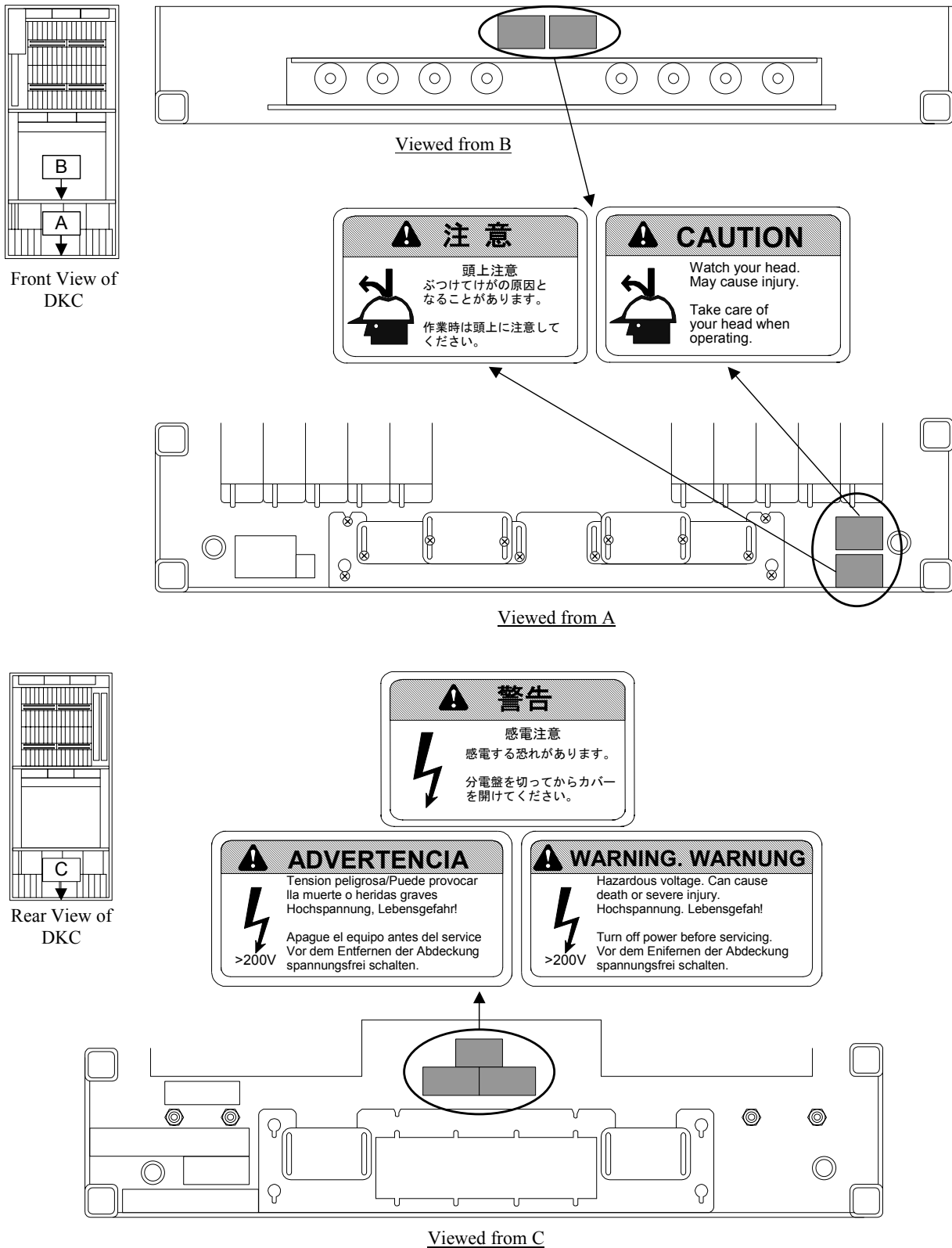

Fig.4-3 Attachment Position of Safety Labels

SAFETY SUMMARY (Continued)

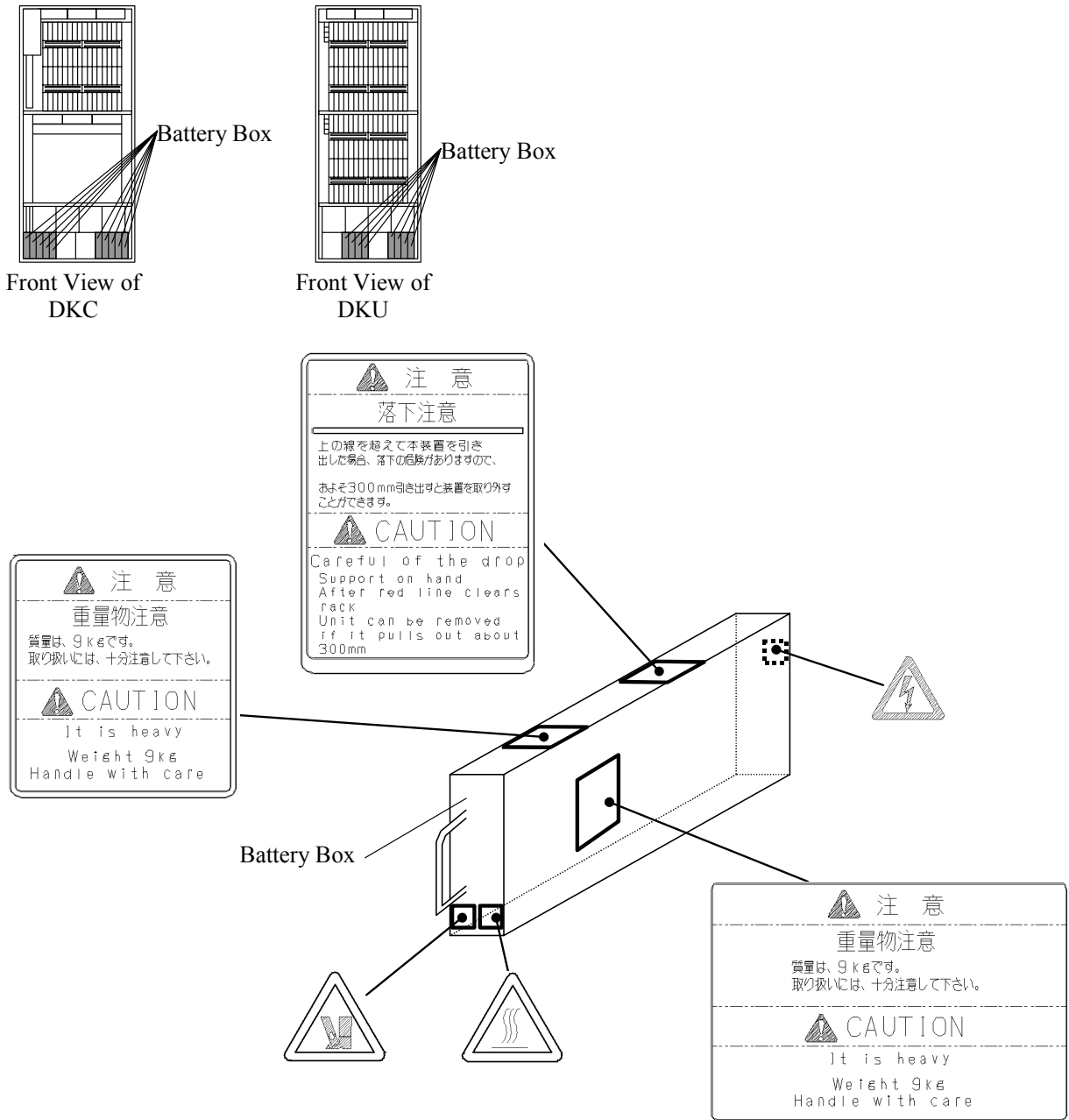
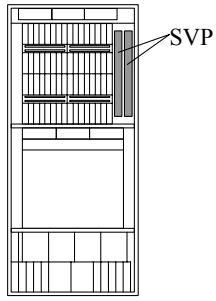

Fig.4-4 Attachment Position of Safety Labels

SAFETY SUMMARY (Continued)



Rear View of DKC

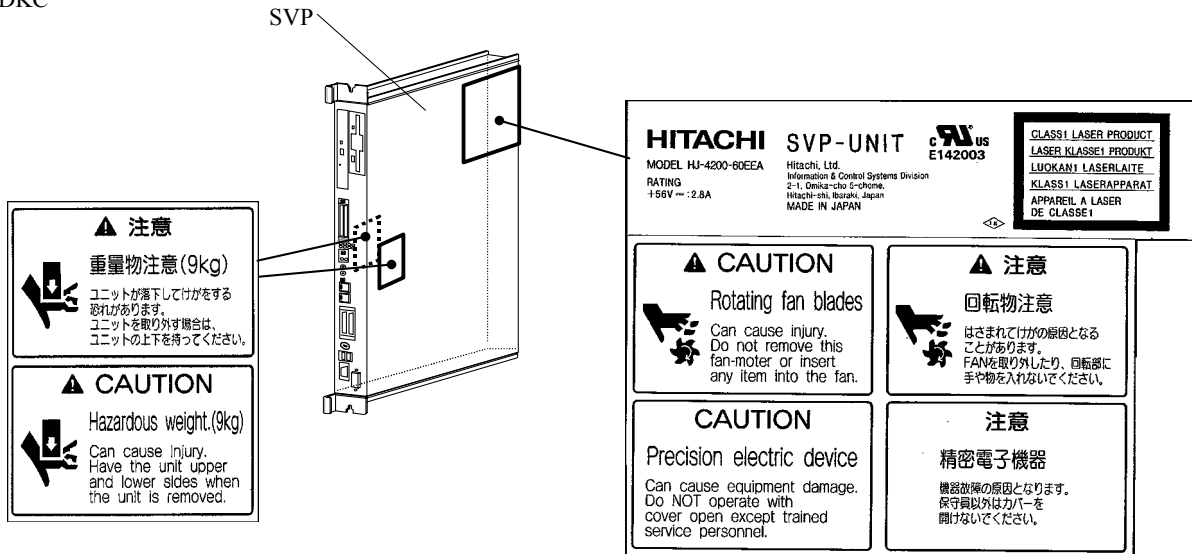
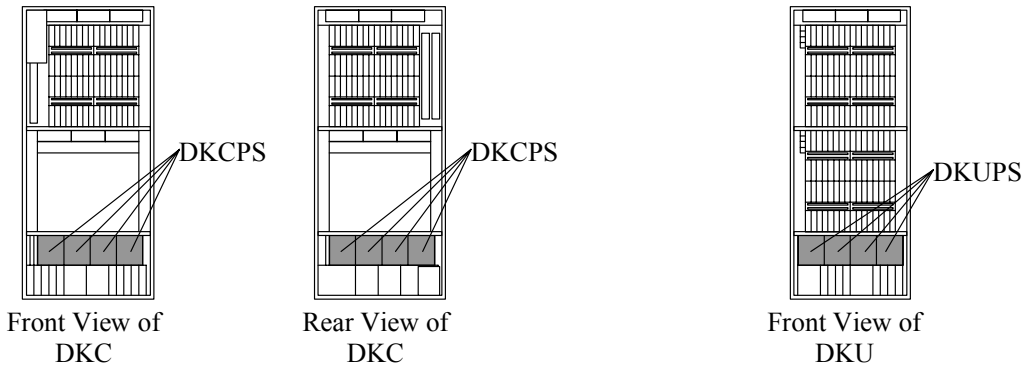

Fig.4-5 Attachment Position of Safety Labels

SAFETY SUMMARY (Continued)



DKCPS/DKUPS (Type 1)



DKCPS/DKUPS (Type 2)

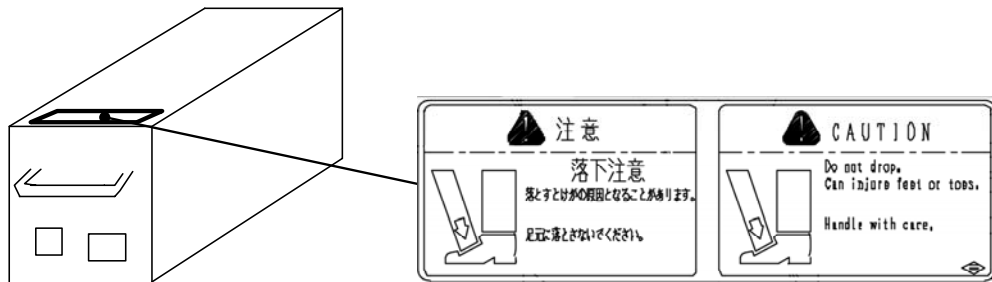

Fig.4-6 Attachment Position of Safety Labels

SAFETY SUMMARY (Continued)

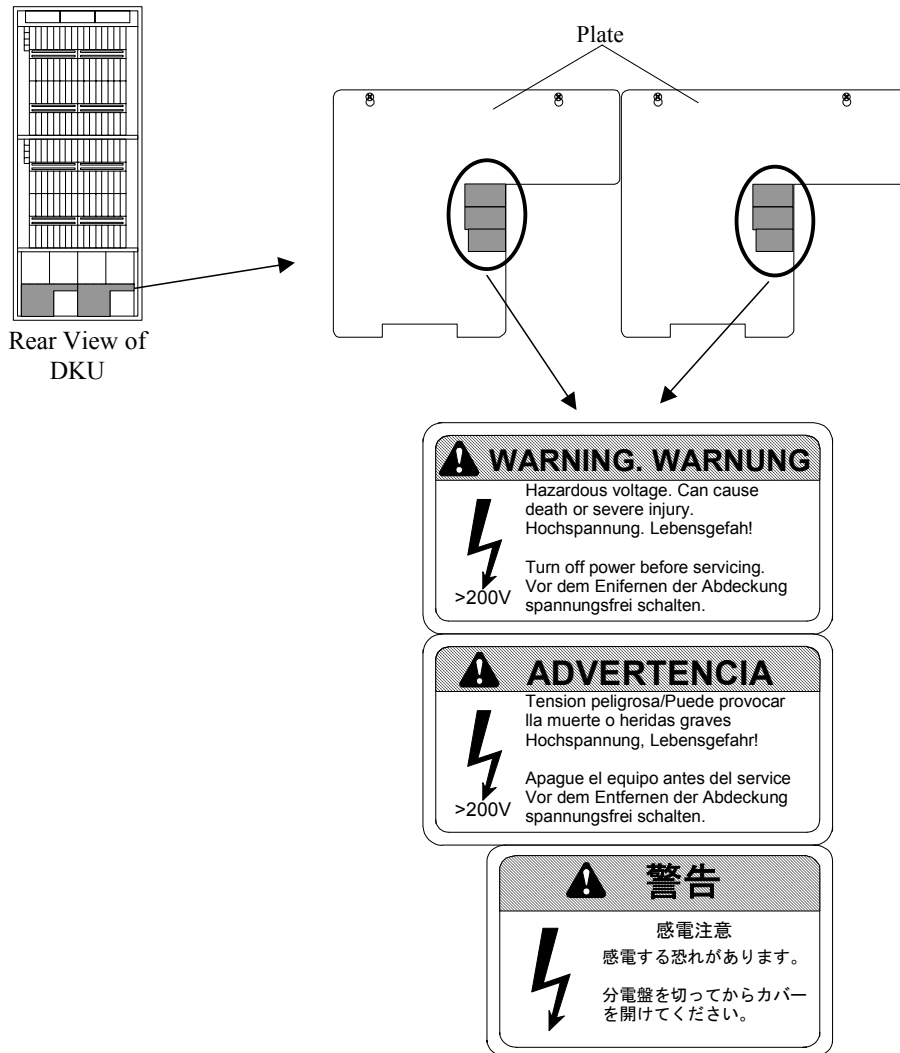

Fig.4-7 Attachment Position of Safety Labels