

SSB SECTION

REV.0	Jun.2001						
-------	----------	--	--	--	--	--	--

Contents

1. Sense Byte Analysis-----	SSB01-10
2. Procedure for Searching Sense Bytes, SIM Error Table and SSB Table -----	SSB02-10
3. 24-BYTE COMPATIBILITY SSB -----	SSB03-10
3.1 Basic Sense Bytes -----	SSB03-10
3.2 Formats and messages -----	SSB03-90
3.3 Details of Sense Bytes -----	SSB03-110
• Format 0, Message ≠ 8/A (Program or system check) -----	SSB03-120
• Format 0, Message 8 (reset notification) -----	SSB03-150
• Format 0, Message A (LCP & overrun, bus out parity check) -----	SSB03-160
• Format 1, Message 0 (Intervention required) -----	SSB03-160
• Format 1, Message X (Drive report error) -----	SSB03-170
• Format 3, Message F (reset allegiance)-----	SSB03-170
• Format 4, Message X (Data check) -----	SSB03-180
• Format 6, Message X (Statistics)-----	SSB03-190
• Format 7, Message 4 (FPC report error) -----	SSB03-200
• Format 8, Message 1 (shared memory failure) -----	SSB03-210
• Format 8, Message 1 (CHK3 Reset)-----	SSB03-220
• Format 8, Message 8 (LCP failure) -----	SSB03-230
• Format 8, Message 8 (MCP failure) -----	SSB03-280
• Format 8, Message 9 (ESCON I/F CHA CHK2:XFR CHK2) -----	SSB03-310
• Format 8, Message 9 (ESCON I/F CHA CHK2:Abnormal Cache Slot Status 1) ----	SSB03-320
• Format 8, Message 9 (ESCON I/F CHA CHK2:Abnormal Cache Slot Status 2) ----	SSB03-330
• Format 8, Message 9 (ESCON I/F CHA CHK2:XFR TIMEOUT) -----	SSB03-340
• Format 8, Message 9 (FICON I/F CHA CHK2 : XFR CHK2) -----	SSB03-341
• Format 8, Message 9 (FICON I/F CHA CHK2 : XFR TIMEOUT) -----	SSB03-342
• Format 8, Message 9 (NAS I/F CHA CHK2) -----	SSB03-343
• Format 8, Message 9 (FIBRE I/F CHA CHK2)-----	SSB03-350
• Format 8, Message A (FCA CHK2) -----	SSB03-370
• Format 8, Message B (DRR CHK2)-----	SSB03-380
• Format 8, Message D (DKU/HDU Power Failure)-----	SSB03-500
• Format 8, Message E (processor failure: CHK1A) -----	SSB03-520
• Format 8, Message E (processor failure: CHA CHK1B) -----	SSB03-560
• Format 8, Message E (processor failure: DKA CHK1B) -----	SSB03-680
• Format 8, Message E (processor failure: Micro WCHK1)-----	SSB03-815
• Format 8, Message E (processor failure: CHK1A) -----	SSB03-820
• Format 8, Message E (processor failure: CHK1B)-----	SSB03-840
• Format 8, Message E (Selective Reset) -----	SSB03-850
• Format 8, Message E (Wait SENSE Timeout) -----	SSB03-860
• Format 8, Message E (CHK1B Reset)-----	SSB03-870
• Format 8, Message E (DKC Internal Reset) -----	SSB03-880
• Format 8, Message E (LCP Internal Reset)-----	SSB03-890
• Format 8, Message E (Force Reset)-----	SSB03-900
• Format 8, Message E (Logical inconsistency reset) -----	SSB03-910
• Format 8, Message F (Micro-program detected error : Logical inconsistency)-----	SSB03-920

• Format F, Message 0 (Operation terminated) -----	SSB03-970
• Format F, Message 1 (Micro-program detected cache failure) -----	SSB03-980
• Format F, Message 2 (Cache Failre)-----	SSB03-990
• Format F, Message 5 (Remote Copy Paths Removed/Restored)-----	SSB03-995
• Format F, Message 6 (CFW impossible) -----	SSB03-1000
• Format F, Message A (NVS terminated)-----	SSB03-1010
• Format F, Message B (HRC/HODM Pair Suspend) -----	SSB03-1020
• Format F, Message F (Cache memory : Correctable error) -----	SSB03-1030
• Format F, Message F (Shared memory : Correctable error)-----	SSB03-1040
• Format F, Message F (Shared memory : Warning)-----	SSB03-1050
• Format F, Message F (Scan : Warning)-----	SSB03-1060
• Format F, Message F (Broadcast : Warning)-----	SSB03-1090
• Format F, Message F (LED BUS : Warning) -----	SSB03-1100
• Format F, Message F (Abnormal MODE : Warning)-----	SSB03-1110
• Format F, Message F (CARB error : Warning)-----	SSB03-1130
• Format F, Message F (CHM DXBF memory : Correctable error) -----	SSB03-1140
• Format F, Message F (CHF DXBF memory : Correctable error) -----	SSB03-1150
4. ECKD 32-BYTE SSB -----	SSB04-10
4.1 Basic Sense Bytes -----	SSB04-10
4.2 Exception Classes and Formats -----	SSB04-50
4.3 Details of Sense Bytes-----	SSB04-60
• Exception 0, Format 3 (Machine condition exception) -----	SSB04-60
• Exception 0, Format 4 (Command sequence exception) -----	SSB04-60
• Exception 4, Format 1 (data exception, PCI, permanent) -----	SSB04-70
• Exception 6, Format 1 (Subsystem information) -----	SSB04-80
• Exception B, Format 0 Exception code 1 (Shared Memory Failure) -----	SSB04-80
• Exception B, Format 0 Exception code 8 (LCP/MCP Failure)-----	SSB04-90
• Exception B, Format 0 Exception code 9 (Host Adapter CHK2) -----	SSB04-90
• Exception B, Format 0 Exception code A (Disk Adapter CHK2)-----	SSB04-100
• Exception B, Format 0 Exception code B (DRR CHK2)-----	SSB04-110
• Exception B, Format 0 Exception code D (Power Failure) -----	SSB04-120
• Exception B, Format 0 Exception code E (Power Failure)-----	SSB04-120
• Exception B, Format 0 Exception code E (Selective Reset Notification/Wait Sense Time Over) -----	SSB04-130
• Exception B, Format 0 Exception F (Logical inconsistency) -----	SSB04-130
• Exception D, Format 1 (FPC report error)-----	SSB04-140
• Exception D, Format 0 (drive report error)-----	SSB04-150
• Exception E, Format 0 (drive report error) -----	SSB04-160
• Exception E, Format 0 (LDEV blockade/Pin volume detected/Write inhibited) -----	SSB04-280
• Exception E, Format 0 (LDEV not ready) -----	SSB04-290

1. Sense Byte Analysis

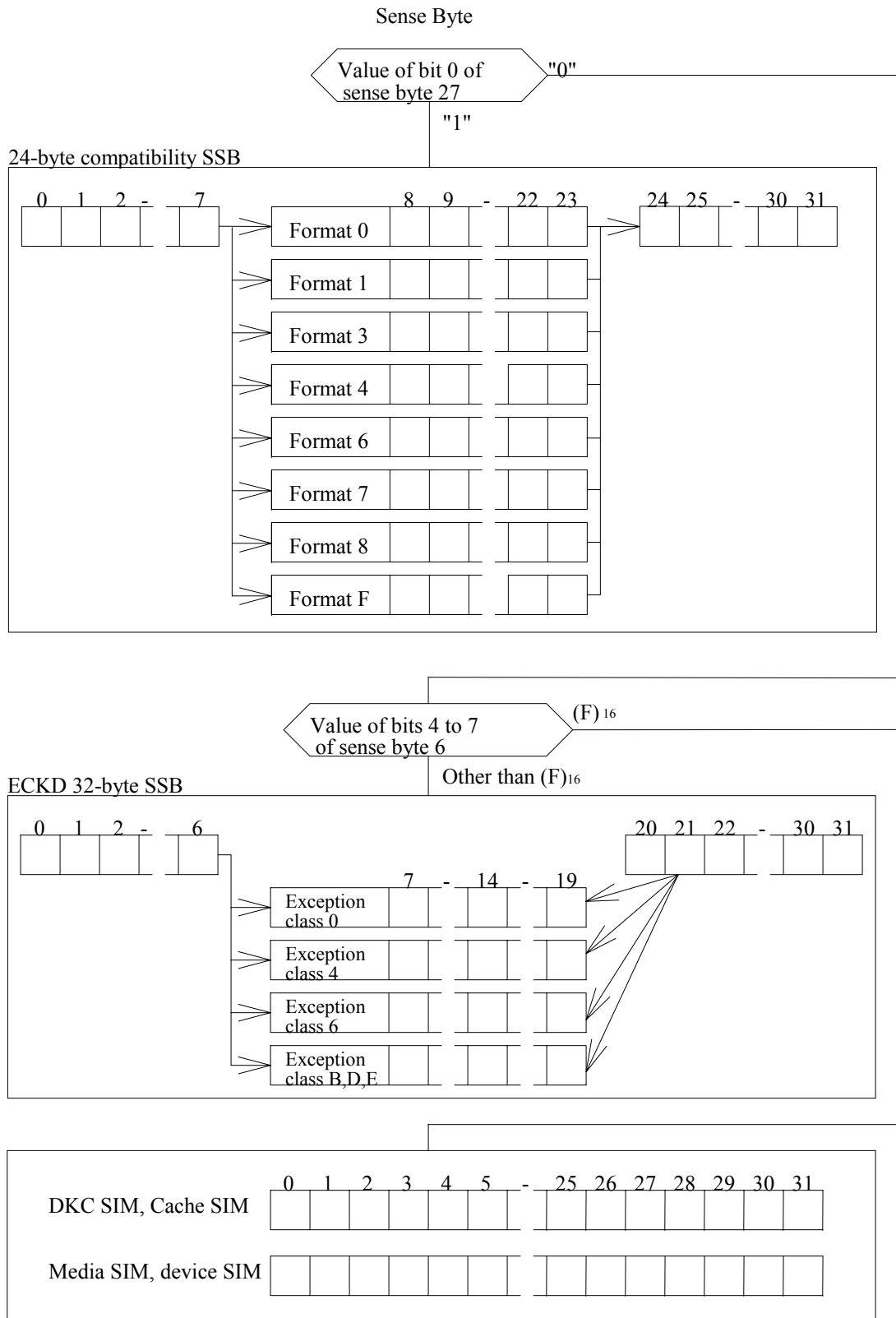

(Note) This section is corresponding to host reported SSBs.
 If you want to know about ssblog on SVP, you should see SSBLOG section.

2. Procedure for Searching Sense Bytes, SIM Error Table and SSB Table

The following table shows the formats for troubleshooting in this disk.

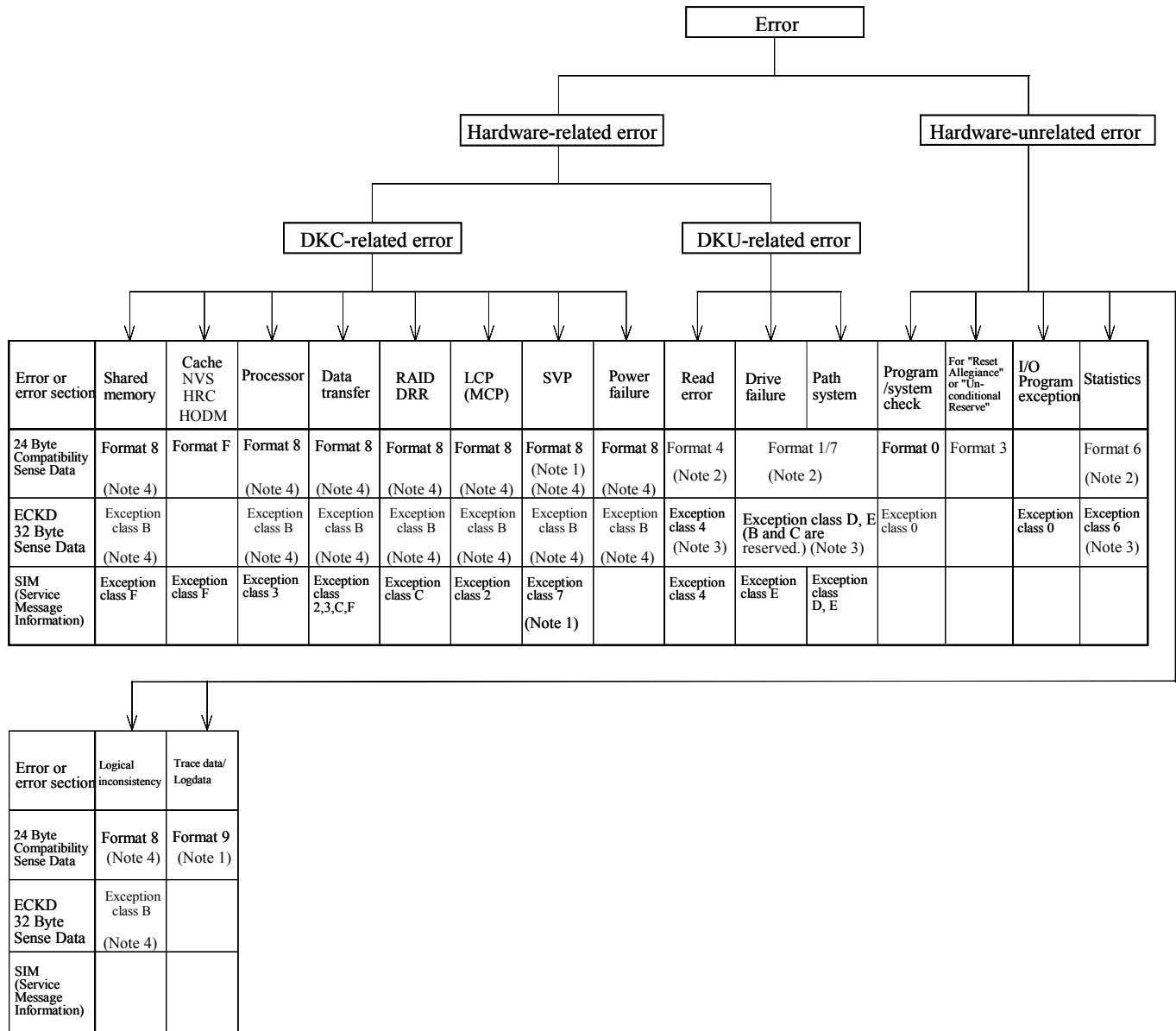

(Note 1) This error is not reported to host. (For SSB log only)

(Note 2) For DKU86I (IBM 3380 emulation mode) only.

(Note 3) For DKU87I (IBM 3390 emulation mode) only.

(Note 4) These SSBs report to host with Exception-class B in 32 Byte SSB, when DKC-Type have configured 3990-6 (Enhance mode).

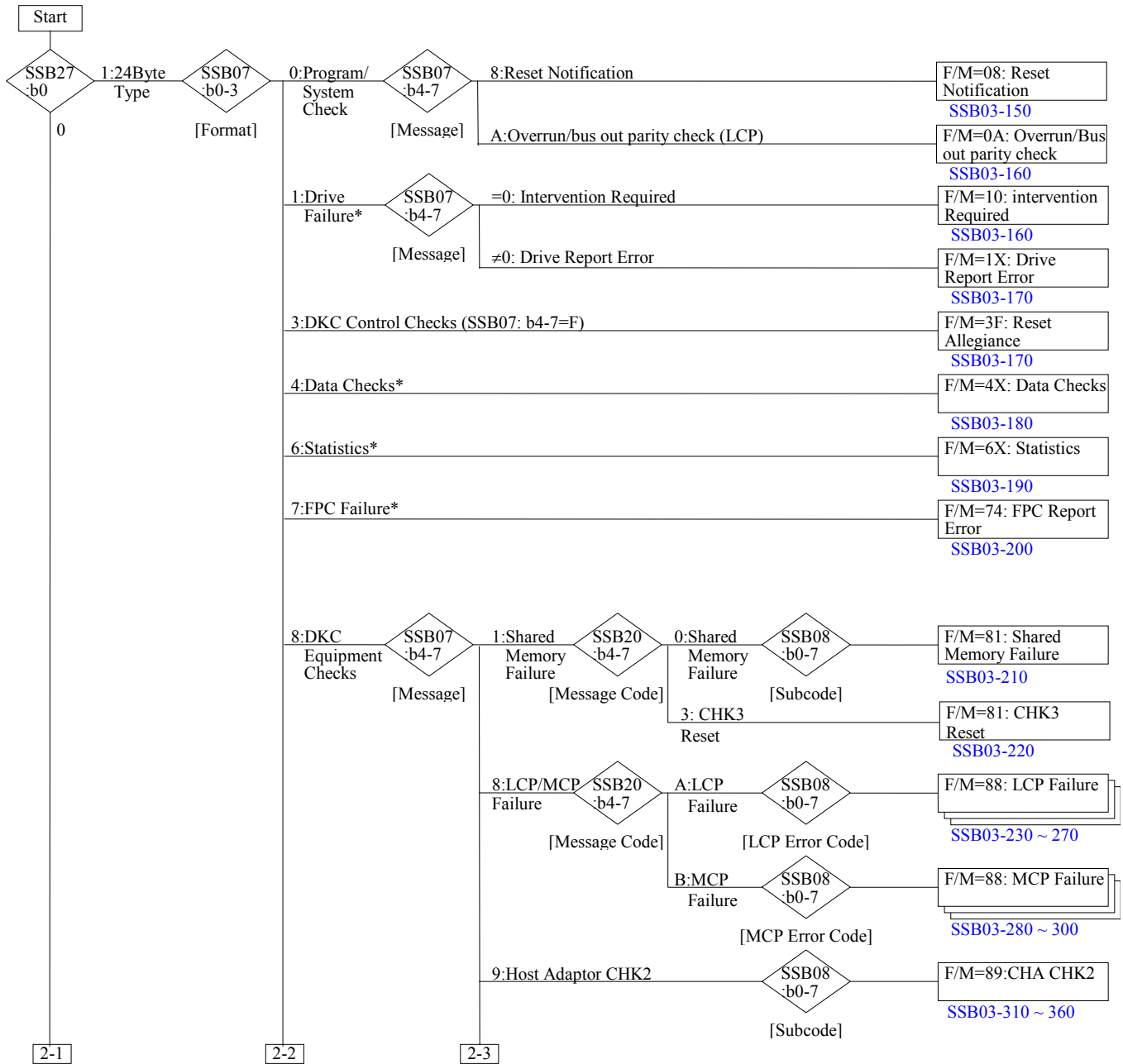

*: For DKU86I (IBM 3380 emulation mode) only.

Search method for SSB tables (1/5)

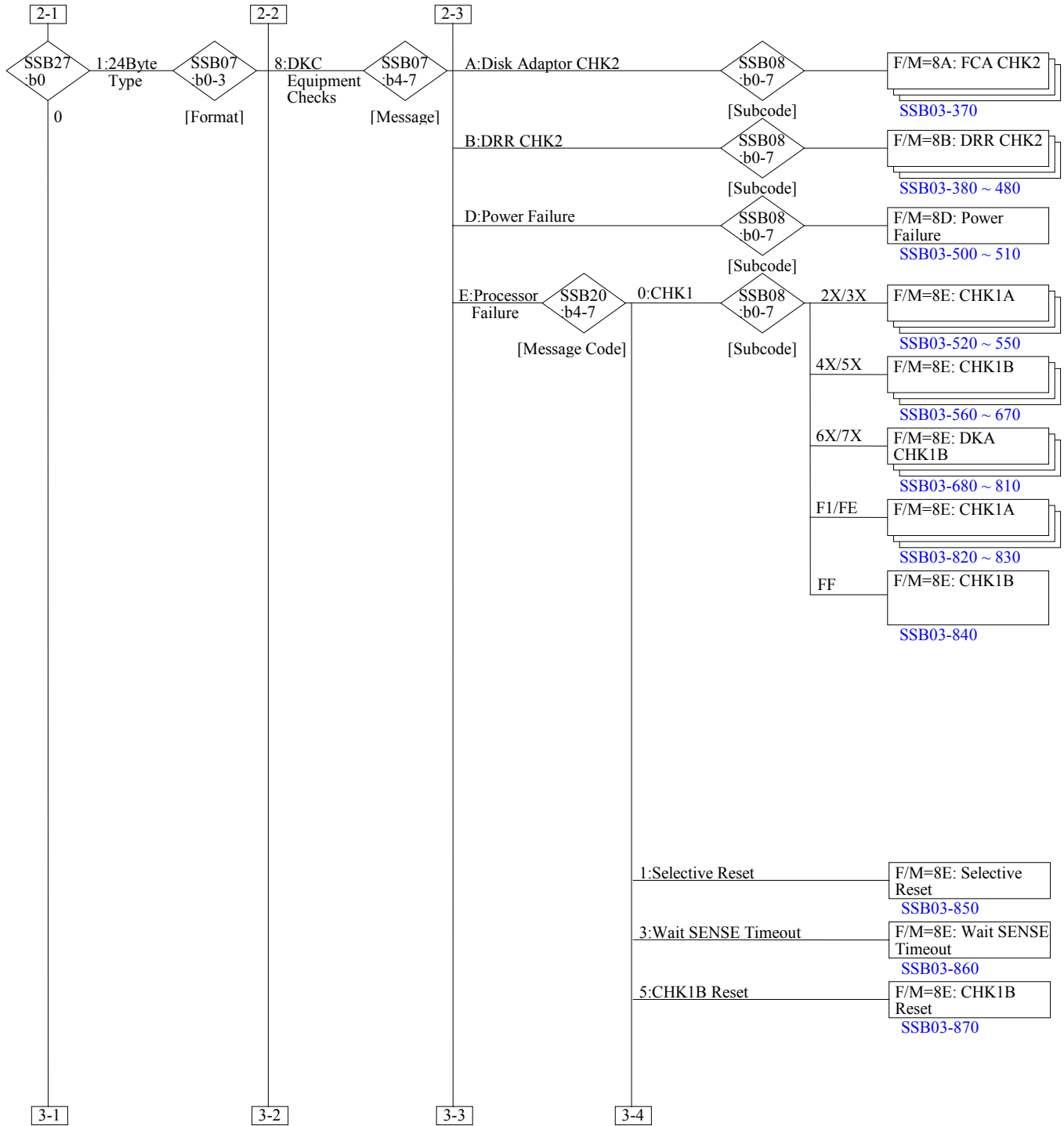

Search method for SSB tables (2/5)

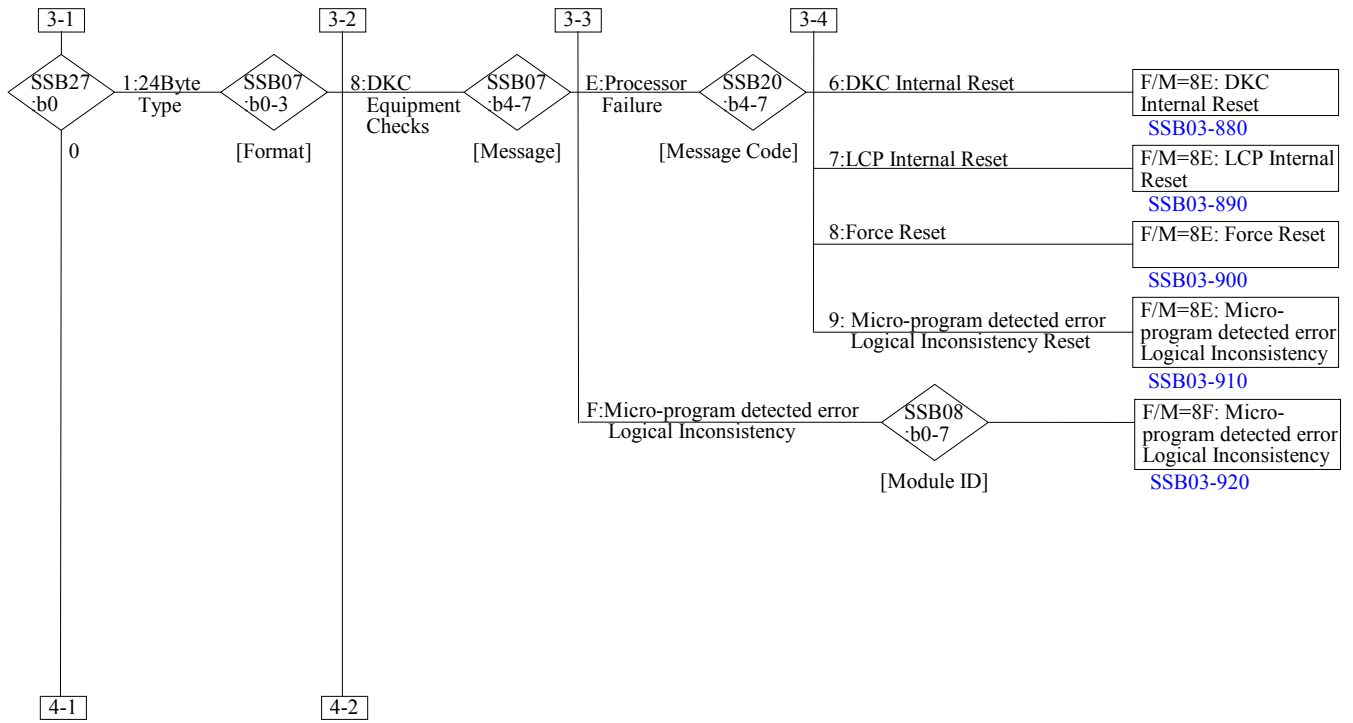

Search method for SSB tables (3/5)

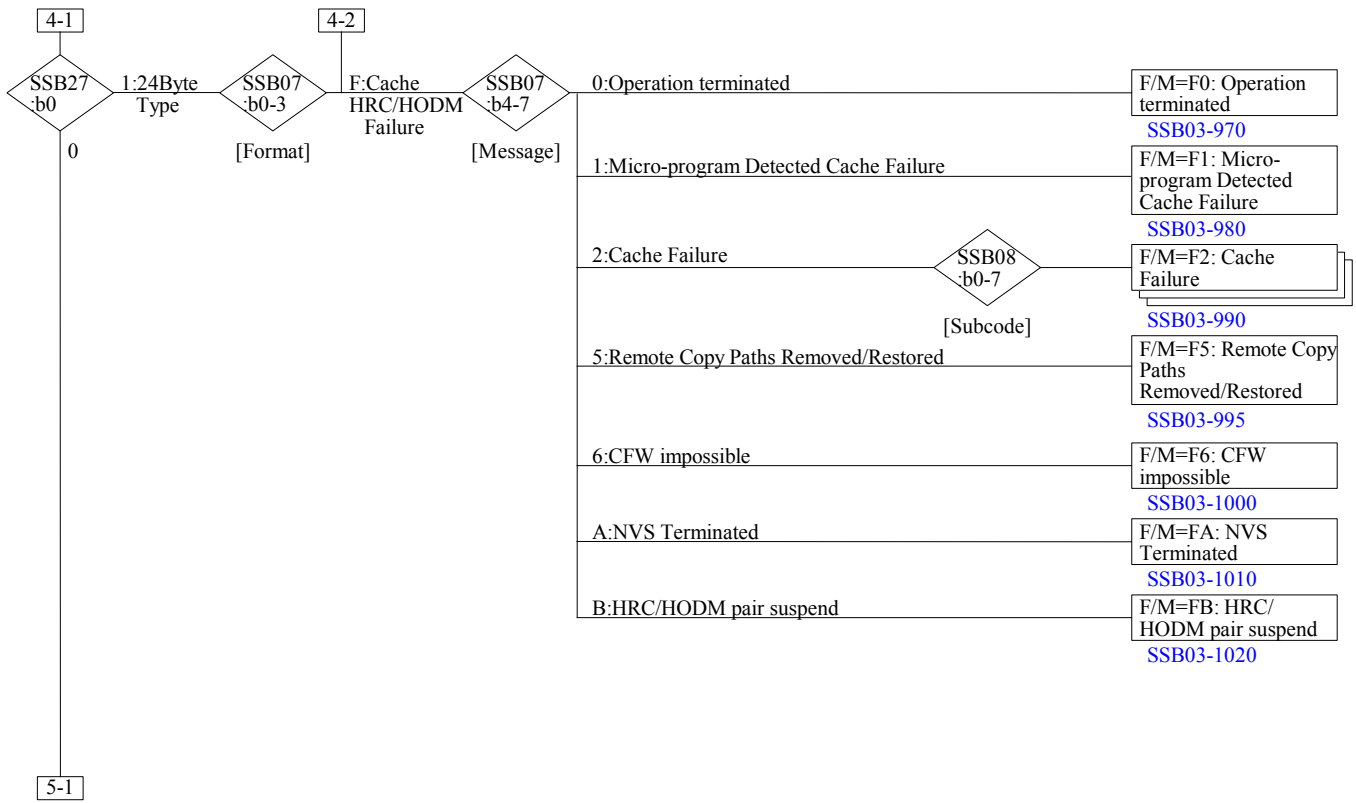

Search method for SSB tables (4/5)

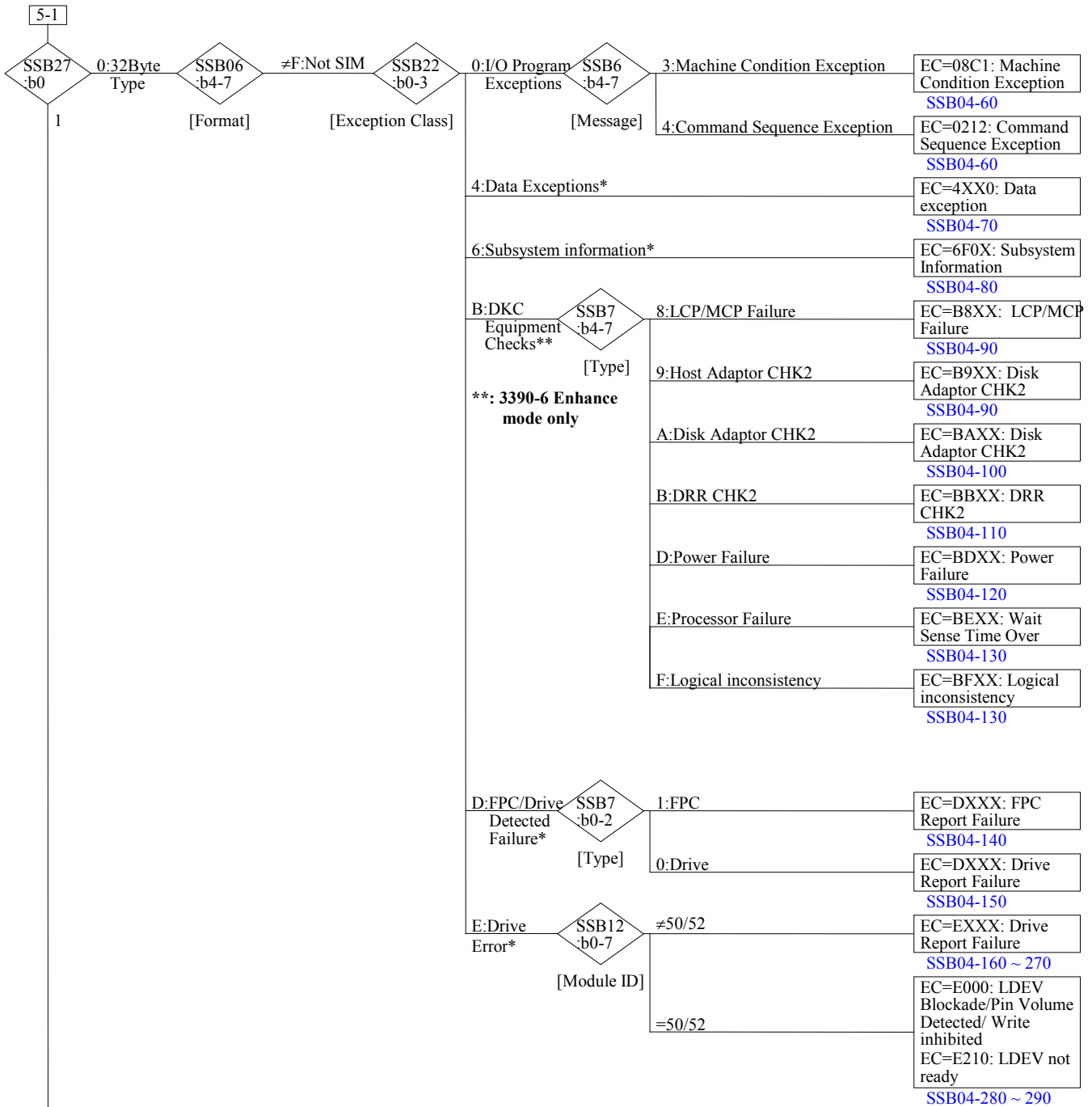

Invalid

*: For DKU871 (IBM 3390 emulation mode)

Search method for SSB tables (5/5)

3. 24-BYTE COMPATIBILITY SSB

3.1 Basic Sense Bytes

Bit Byte	24-Byte Compatibility Sense Data							
	0	1	2	3	4	5	6	7
0	Command reject	Intervention required	Busout parity check	Device check	Date check	Overrun	Not used	Incomplete domain
1	Permanent error	Invalid track format	End of cylinder	Operator message	No record found	File protection	Write inhibit	Imprecise ending
2	Request inhibit write	Correctable	First log mode error	Environmental data present	Not used	Imprecise ending	Not used	
3	Controller ID, number of retries, number of records							
4	Device address							
5	Low cylinder address, overflow flag of command overruns							
6	Head address and high cylinder address, overflow flag of data overruns							
7	Format				Message			
8 to 23	Bytes 8 to 23: Depends on the format and message.							
24	Logging and message control							
25	Duplex pair error	Program action code						
26	Dual frame	EDCC mode	Duplex pair	Sub-volume error	Nonsynchronous operation	Serial channel	Not used	Permanent path error
27	24-byte SSB	Device address valid	Track address valid	Not used	DKU86I track compatible mode	Not used	Path number	
28	Not used							
29	Cylinder address							
30								
31	Head address							

Byte	Bit	Name	Description
0	0	Command reject	<ol style="list-style-type: none"> Invalid command was received The sequence of commands is invalid The number of bytes sent by a CONTROL command is insufficient or the value is invalid A WRITE command that violates the file mask and search conditions was received. A WRITE command was received when the R/W switch was set to READ. (In this case, bit 6 of byte 1 (write inhibit) also becomes "1".) The WRITE SPECIAL HA command does not permit a short byte. An attempt to write an Rn record to a defective track was made. No link is established for a defective or alternate track. The command issued in the LOCATE domain does not match the operation specified by the LOCATE command. The operation specified by the LOCATE command has violated the file mask. An attempt was made to access an alternate track beyond the user cylinder during multi-track operation in the LOCATE domain. (File protected (bit 5 of byte 1) is set at the same time.) The status of the cache/device does not meet the requirement of the SET SUB MD/PERF SUB FUNC command
	1	Intervention required	<ol style="list-style-type: none"> The addressed device is not READY. The DKU is in the CE mode. The addressed device is not physically connected
	2	Busout check	The data or command transferred from the channel has a parity error.
	3	Device check	A malfunction was detected in the subsystem. Details are indicated in Bytes 7 to 31.
	4	Data check	<ol style="list-style-type: none"> A correctable read error was detected in the data read from the device. (Bit 1 of byte 2 ("correctable") is set at the same time. The information for correction is indicated in sense bytes 15 to 23.) An uncorrectable read error was detected in the data read from the device. The end by the PCI fetch mode is indicated. Bit 1 of byte 2 ("correctable") is set at the same time and restart displacement is guaranteed. Error displacement and error pattern are 0.
	5	Overrun	<ol style="list-style-type: none"> A response to a data request or reconnection request could not be received within the predetermined time on the parallel channel. This error is reported with F/M=0A. No response was made or an invalid frame was received when the serial channel was in a data transfer sequence; so, retry was impossible. Command retry (overrun) was requested from the channel, but retry was impossible. This error is reported with F/M=0A. Termination of overrun was requested from the channel. This error is reported with F/M=0A. <p>Note: This bit is set on if ten overruns have occurred through command retry including the format write command. (Permanent error (bit 0 of byte 1) is not set.) If a data overrun has occurred with a WRITE command, data transfer is aborted immediately and (00H) is written till the end of that record.</p>
	6	Not used	Always 0
	7	Incomplete domain	This bit is set if a short domain has been detected during a write in asynchronous transfer. Environmental data present (bit 3 of byte 2) is also set to '1'.
1	0	Permanent error	Command retry failed.

Byte	Bit	Name	Description
1	1	Invalid track format	<ol style="list-style-type: none"> 1. An index was encountered during a data write. (A data write beyond the track capacity was made.) 2. An index marker was detected in the key or data field when the READ or SEARCH command (except SCH ID) was handling a record. 3. An updating write was attempted for a record with a different size from the record size specified in TLF of the LOCATE command or the block length of the DEF EXT command. 4. The length of the data field of R0 was not 8 bytes during WRITE TRK operation.
	2	End of cylinder	An attempt was made to perform track switching from the last track of the logical cylinder by a READ or SEARCH command with multi-track specification. (End of cylinder is not reported in the LOCATE domain.)
	3	Message to operator	This bit is set to display an error to the operator.
	4	No record found	<ol style="list-style-type: none"> 1. Two index markers were detected in the same command chain without intervention of a WRITE or SENSE command or a read operation that handles the HA or data field. 2. The target record searched for by a LOCATE command could not be detected. Imprecise ending (bit 7 of byte 1) is also set at the same time.
	5	File protected	<ol style="list-style-type: none"> 1. A SEEK command has violated the file mask or extent range. 2. A READ or SEARCH command with multi-track specification has violated the file mask or extent range. 3. An attempt was made to access an alternate track beyond the user cylinder during multi-track operation in the LOCATE domain. (Command reject (bit 0 of byte 0) is also set at the same time.) 4. Multi-track operation was tried directly to an alternate track in the asynchronous mode. 5. The track set is out of the extent specified for WRITE ANY/READ ANY. 6. The LOCATE RECORD/LOCATE RECORD EXTENDED domain is out of extent.
	6	Write inhibit	<ol style="list-style-type: none"> 1. A WRITE command was received when the R/W switch was set to READ. (Bit 0 of byte 0 (command rejection) also becomes "1".) 2. Indicates that the write prohibition status has been established by the DIAG CTL command. (Bit 3 of byte 0 (device check) is also set at the same time.)
	7	Imprecise ending	Indicates that the error indicated in the sense byte is due to a command before the command that reported the unit check. (abnormal end in the LOCATE domain) Bit 5 of byte 2 is also set at the same time.
2	0	Request inhibit write	Requests issuance of a DIAG CTL command that instructs prohibition of a write through the path to avoid an error from which the path cannot recover. (At the same time, the faulty section is set in byte 25 "program action code".)
	1	Correctable	Indicates that bit 4 of sense byte 0 (data check) can be corrected. Restart displacement, error displacement, and error pattern are indicated in bytes 15 to 23.
	2	First log mode error	The number of occurrences of seek/data errors exceeded the threshold. (Bit 3 of byte 2 (environmental data present) is also set at the same time.)
	3	Environmental data present	Indicates that this SSB is not due to the current CCW chain but it is the statistics to be reported from the DKC to the host. The statistics include log information and reset notification.
	4	Not used	Always 0
	5	Imprecise ending	Same as bit 7 of byte 1
	6	Not used	Always 0
7	Not used	Always 0	

Byte	Bit	Name	Description								
3	0 7	Controller ID, number of retries, number of records	<ol style="list-style-type: none"> 1. Controller ID (Format 1, 6, 7, 8, or F, without imprecise ending) 2. Number of retries (Format 4 or 5, without imprecise ending, and environmental data present = 1) 3. Number of remaining records or tracks in the LOCATE domain (when indeterminate end or file protection is 1) 4. Zero (For other than 1 to 3 above) 								
4	0 1 2 3 7	<table border="1"> <tr> <td>0</td> <td>SP number 2^1</td> </tr> <tr> <td>1</td> <td>SP number 2^0</td> </tr> <tr> <td>2</td> <td>Controller number</td> </tr> <tr> <td>3</td> <td>DKU physical device number</td> </tr> </table>	0	SP number 2^1	1	SP number 2^0	2	Controller number	3	DKU physical device number	
0	SP number 2^1										
1	SP number 2^0										
2	Controller number										
3	DKU physical device number										
5	0 7	<table border="1"> <tr> <td>Lower digits of cylinder address</td> <td>Indicates the lower digits of the cylinder address of the seek address received from the last channel (2^7 to 2^0).</td> </tr> <tr> <td>Overflow flag of command overruns</td> <td>Set to x'01' when the command overrun threshold is exceeded. (For format 6 only)</td> </tr> </table>	Lower digits of cylinder address	Indicates the lower digits of the cylinder address of the seek address received from the last channel (2^7 to 2^0).	Overflow flag of command overruns	Set to x'01' when the command overrun threshold is exceeded. (For format 6 only)					
Lower digits of cylinder address	Indicates the lower digits of the cylinder address of the seek address received from the last channel (2^7 to 2^0).										
Overflow flag of command overruns	Set to x'01' when the command overrun threshold is exceeded. (For format 6 only)										

Byte	Bit	Name	Description
6	0 3	Upper digits of cylinder address	(1) Indicates the upper digits of sense byte 5. Indicates the upper digits of the cylinder address of the last seek address received from the channel.
	4 7	Head address	(1) Indicates the head address of the last seek address received from the channel. This address is updated in multi-track operation.
	0 7	Overflow flag of data overruns	(2) Set to x'01' when the data overrun threshold is exceeded. (For format 6 only)
7	0 3	Format	The following indicate the meanings of sense bytes 8 to 23. 0000 Format 0 Program check or system check 0001 Format 1 Drive failure *1 0010 Format 2 DKC function check (Not used) 0011 Format 3 DKC control check 0100 Format 4 Data check without information for correction *1 0101 Format 5 Data check with information for correction (Not used) 0110 Format 6 Statistics *1 0111 Format 7 SPC Failure *1 1000 Format 8 Microprogram detected error or DKC/DKU failure 1001 Format 9 Microprogram detected error 1110 Format E Service information message (SIM) (Not used) 1111 Format F Cache system error
	4 7	Message	Indicates the determined characteristics of the error status for the above formats. Hexadecimal digits of 0 to F indicated in bits 4 to 7 correspond to 0 to F for messages.
24	0-2	Logging message	Reserved
	3		Logging mode
	4 5	control	Logging action (only '01' used) 00: Not logged 01: Unconditionally logged 10: Only the first record logged at retry 11: Only the first record logged upon occurrence of a permanent error
	6 7		Operator message control (only '01' used) 00: No operator message 01: Message unconditionally output 10: Message output only for the first record at retry 11: Message output only for the first record upon occurrence of a permanent error.

*1: For DKU86I (IBM 3380 emulation mode) only.

Byte	Bit	Name	Description
25	0	Program action code	Duplex pair volume error (Not used) Indicates the error on a duplex pair (neither pending nor suspended). This bit is set to 1 for device check or intervention request. F/M=1/7/8
	1-7		Instructs the method of error recovery. (00) ₁₆ : No action (10) ₁₆ : SIM (Not used) (16) ₁₆ : Reset notification (17) ₁₆ or (57) ₁₆ : Device check with FMT=7/8 during write operation. Prohibits write to the controller if a permanent error has occurred on that path. (18) ₁₆ or (58) ₁₆ : Device check during write operation. Prohibits write to the channel path if a permanent error has occurred on that path. (19) ₁₆ or (59) ₁₆ : Device check during write operation. Prohibits write to the storage path if a permanent error has occurred on that path. (70) ₁₆ : The command was rejected because the condition specified in the specific blocking condition setting order of the PERF SUB FUNC command was met. (71) ₁₆ : Attention was reported from the interface placed in the specific blocking status by the PERF SUB FUNC command. (1D) ₁₆ : The subsystem or device is in the State Change Pending status (statistics send (bit 3 of byte 2) = 1, F/M = F0).
26	0	Configuration information	Dual-frame configuration 0: Single-frame configuration 1: Dual-frame configuration
	1		EDCC mode 0: DCC 1: EDCC
	2		Duplex pair indication (Not used) 0: Simplex 1: Duplex pair
	3		Sub-volume error indication (Not used) 0: Not a sub-volume error 1: Sub-volume error
	4		Nonsynchronous operation 0: Synchronous operation 1: Nonsynchronous operation
	5		Serial channel 0: Parallel channel 1: Serial channel
	6		Not used
	7		Permanent path error 0: Permanent error for all paths 1: Permanent error for this path

Byte	Bit	Name	Description
27	0	Configuration information	24-byte SSB indication 0: Indicates 32-byte SSB. 1: Indicates 24-byte SSB.
	1		Device address valid 0: Device address in byte 4 is invalid. 1: Device address in byte 4 is valid.
	2		Track address valid 0: Track address in bytes 29 to 31 is invalid. 1: Track address in bytes 29 to 31 is valid.
	3		Not used
	4		DKU86I track compatible mode 0: Not in DKU86I track compatible mode 1: In DKU86I track compatible mode or changing to DKU86I track compatible mode
	5		Not used
	6-7		Fence path (1) Fence path: When operator message (bit 3 of byte 1) = 1 and F/M = 03 (2) SSB creation path: For other than the above
28	0	Message code	F/M=4X, MT0=1: Sub-retry succeeded ('01')
			F/M=F4, MT0=1: Cache stopped ('04')
	7		F/M=F7, MT0=1: Invalid track format ('07')
			F/M=FA, MT0=1: NVS stopped ('0A')
			F/M=FB, MT0=1: Suspend duplex ('0B')

Byte	Bit	Name	Description
29	0	Cylinder address	Not used
	3		
	4		
	5		
	6		
30	7	Cylinder address	Cylinder 2048
	0		Cylinder 1024
	1		Cylinder 512
	2		Cylinder 256
	3		Cylinder 128
	4		Cylinder 64
	5		Cylinder 32
	6		Cylinder 16
31	7	Head address	Cylinder 8
	0		Cylinder 4
	1		Cylinder 2
	2		Cylinder 1
	3		Not used
31	4	Head address	Head 8
	5		Head 4
	6		Head 2
	7		Head 1
	7		Head 1

3.2 Formats and messages

(1/2)

Format	Message	Description	
0		Operator message (bit 3 of byte 1) = 0	Operator message (bit 3 of byte 1) = 1
	0	No message	Not used
	1	Invalid command	Log mode end (Not used)
	2	Invalid sequence	Not used
	3	Data count is fewer than the specified number.	Device was fenced. (Not used)
	4	Data value differs from the specified number.	Not used
	5	The file mask allows neither RD SP HA nor WR SP HA.	
	6	The channel isolated the retry.	
	7	The channel sent an incorrect retry command.	
	8	System reset was received (reset notification).	
	9	Not used	
	A	Overrun/bus out parity check (LCP)	
	B	Improper instruction for a defective track or alternate track	
	C	Not used	
	D	ECM software error (Not used)	
	E	Invalid command for sub-volume (Not used)	
F	Invalid status (reason code in byte 8)		
1	0	Intervention required	For DKU86I only
	1	Not used	
	2	Drive not ready	
	3	Not used	
	4	Drive report error	
	5-F	Not used	
3	0-E	Not used	
	F	Reset allegiance	
4	0	Data check in HA field	For DKU86I only
	1	Data check in C field	
	2	Data check in K field	
	3	Data check in D field	
	4	Not used	
	5	PA error	
	6-F	Not used	
6	0-7	Statistics	
	8~F	Not used	
7	0-3	Not used	
	4	SPC report error	
	5-8	Not used	
	9	SCSI bus parity error	
	A-F	Not used	

(2/2)

Format	Message	Description
8	0	Reserved
	1	Shared memory failure
	2	Not used
	3-7	Reserved
	8	LCP failure/MCP failure
	9	Host adapter CHK-2
	A	Disk adapter CHK-2
	B	DRR failure
	C	Reserved (for SSB log)
	D	Power failure
	E	Processor failure
9	F	Microprogram detected error (Logical inconsistency)
	0-E	Reserved
F	F	Microprogram detected error (Trace data/Log data) (For SSB log)
	0	Operation terminated
	1	Microprogram detected cache failure
	2	Cache failure
	3	Reserved
	4	Not used
	5	Remote Copy Paths Removed/Restored
	6	CFW impossible
	7	Invalid track format (Does not occur with RAID200.)
	8-9	Reserved
	A	NVS terminated
	B	HRC/HODM Pair suspend
	C-E	Reserved
	F	Cache/Shared memory/M-bus/F-bus/J-bus warning

3.3 Details of Sense Bytes

Format 0, Message \neq 8/A (Program or system check)

	0	1	2	3	4	5	6	7
7	Format (x'0')				Message(x'X' : x \neq 8, A)			
8	Reason code when F/M = 0F Command code when F/M \neq 0F							
9	Error detail information (Note 1)							
10								
11								
12								
13	SSID of mate subsystem							
14	(x'0000' for EDCC)							
15	Manufacturer code ('000000')						Factory code ('00')	
16	Module ID							
17	Routine ID							
18	Processor No. CHA (0-7) DKA (8-F)				Error detail information (Note 2)			
19	SSID of self subsystem							
20								
21								
22	Symptom code (x'0F0X' : X = message code) (Note 3)							
23								

(Note 1)

(1) Issued command information when F/M=02

B\b	0	1	2	3	4	5	6	7
9	SCH ID	SCH KEY	Locate, LC EXT	SK, SK CYL	RD IPL	RECAL	SUSP MPR	RD C
10	DIAG CTL	DIAG CTL (LOC DOM)	DEF EXT	SET FM	SET SUB MODE	SP C	WR CKD	WR R0
11	SET INTF ID	DIAG CTL (PRE REM)	0	Other command	RD C chaining	All byte match	LC domain	Erase execute
12	Pseud through	0	0	Allow WR KD	Allow WR D	Allow WR CKD	Allow WR R0	Allow WR HA

(2) Short byte flag when F/M=03

x'0040 0000'

(3) Mask information when F/M=05

Byte 9 : Mask for write control

x'00' : Allows all write operation except
WR HA, WR R0.

x'40' : Inhibits all write operation.

x'80' : Allows update write operation.

x'C0' : Allows all write operation.

Byte 10 : Mask for seek control

x'00' : Allows all seek commands and RECAL.

x'08' : Allows SK CYL and SK HD only.

x'10' : Allows SK HD only.

x'18' : Inhibits all seek command and multi
operation.

Byte 11 : Mask for access

x'00' : Allows normal access.

x'02' : Allows device support.

x'04' : Allows diagnostic access.

x'06' : Allows device support inhibit data
check correction and retry.

Byte 12 : Not used

- (4) Record address when other F/M
 Byte 9 and 10 : Cylinder address
 Byte 11 : Head address
 Byte 12 : Record number

- (Note 2) Bit 4-7 of byte 18 : Type of byte 19
 x'08' : Byte 19 is cylinder address (high).
 x'09' : Byte 19 is cylinder address (low).
 x'0A' : Byte 19 is head address (high).
 x'0B' : Byte 19 is head address (low).
 x'0C' : Byte 19 is record number.
 Byte 19 : One byte of CCHHR.

- (Note 3) x'2F00' for dummy SENSE

Reason code list for Format 0, Message F (1/2)

Code	Reason
00	No messages
01	An attempt was made to make a cache usable but the cache was in the pending status.
02	Not used
03	An attempt was made to forcibly make a cache unusable but the cache was not holding destage completion.
04	An attempt was made to activate a CFW but the CFW was in the ending status.
05	An attempt was made to perform caching for a device but a cache was in the pending status.
06	An attempt was made to destage a track but an NVS was in the failed status.
07	An attempt was made to make an NVS unusable but the NVS was being initialized.
08	An attempt was made to halt or discarded caching/DFW for a device but the DFW of the device was in the failed status.
09	An attempt was made to forcibly halt a DFW of a device but the device was not in the following status. <ul style="list-style-type: none"> • The DFW was in the pending status. • The DFW was in the failed status. • An NVS was failed. The data was in the NVS but not in the cache.
0A	An attempt was made to make an NVS usable but a DFW of a device was in the pending or failed status.
0B	An attempt was made to make an NVS usable but the NVS was in the pending status.
0C	An attempt was made to halt caching/DFW of a device when an NVS was failed but the data of the device was in the NVS but not in the cache.
0D	An NVS was requested by a command but the NVS was unusable.
0E	A cache was requested by a command but the cache was unusable.
0F	Not used
10-24	Not used
25	(TPF,RC) A SSM command (subcommand: Make Cache Unavailable to Subsystem) was received while a cache storage initialization procedure was underway.
26-27	Not used
28	(TPF,RC) A PSF command (Order: Prepare for Read Subsystem Data, Suborder: X'05') was received when cache was not available or pending.
29	The PSF command of specific blocking status setting order was issued from an interface having no path group.
2A	An attempt was made to make a path group having parallel and serial channels intermixed.
2B	A message buffer is full.
2C-2F	Not used

Reason code list for Format 0, Message F (2/2)

Code	Reason
30	(TPF,RC) The cache partition indicated by PSF command (Order: Prepare for Read Subsystem Data) was not initialized.
31-34	Not used
35	SET GUARANTEED PATH sub-command was issued to a path in a fence.
36-39	Not used
3A	(TPF,RC) Read or Search or Write commands were received while 3380 Track Compatibility Mode.
3B-3E	Not used
3F	An attempt was made to execute the MAKE NVS AVAIL FOR SUB sub-command but the NVS was disabled because the 'enable/disable NVS capability' has been set to 'disable' in a VPD.
40	Not used
41	An ordinary command was issued to a device being reserved for media maintenance.
42-7F	Not used
80	A specific command was issued on an interface which has been in the specific command blocking status by the SET SPECIAL INTERCEPT CONDITION order of the PSF command.
81	An attention was reported to an interface which has been in the specific command blocking status by the SET SPECIAL INTERCEPT CONDITION order of the PSF command.
82-8F	Not used
90	(TPF,RC) 1. A Locate Record Extended command was received on a 3990 that have ESCON channel capability. 2. A PSF command (one of these orders: Establish Duplex Pair, Terminate Duplex Pair, Suspend Duplex Pair, or Direct I/O to One Device of the Duplex Pair) was received. 3. A PSF command (Order: Prepare for Read Subsystem Data, Suborder: X'04') was received. 4. A PSF command (one of these orders: Prepare for Read Subsystem Data, Set Lock State, Purge Lock, Unlock, Connect, or Disconnect) was received in the case of MPLF feature was not installed.
91	(TPF,MPLF)Specified MPLP had not been initialized and the cache was not in an available status.
92	(TPF,RC) A SSS command was rejected because additional pinned data still existed.
93	(TPF,MPLF) A cache storage control command was received when Disconnect order was in progress for any MPLP.
94	(TPF,RC) Destage Modified Tracks order was received while a scan of the cache for modified data is underway, which was initiated from the receipt of a prior Destage Modified Tracks order.
95	(TPF,MPLF) The attention message buffer was full when the order which has the potential of generating attention interrupt was received.
96-FF	Not used

Format 0, Message 8 (reset notification)

	0	1	2	3	4	5	6	7
7	Format (x'0')				Message (x'8')			
8	x'00'							
9								
10								
11	Hardware level (Note)							
12								
13	SSID of mate subsystem							
14	(x'0000' for EDCC)							
15	Manufacturer code ('000000')						Factory code ('00')	
16	Module ID							
17	Routine ID							
18	Processor No.				Not used			
19	Not used							
20	SSID of self subsystem							
21								
22	Symptom code (x'2FFF')							
23								

(Note) Hardware level

Bit 0 : Hardware level

When the bit 0 = 0,

- Bit 1: Not used
- Bit 2-3: Reported storage path
- Bit 4-5: Number of channels per cluster
 - 00 : 4
 - 01 : 8
 - 10 : Not used
 - 11 : Not used
- Bit 6: NVS
 - 0 : Not exist
 - 1 : Exist
- Bit 7: Not used
- Bit 8-10: Cache size
 - 000 : Non cache
 - 001 : 256MB
 - 010 : 512MB
 - 011 : 768MB
 - 100 : 1024MB
 - 101 : 1280MB
 - 110 : 1536MB
 - 111 : Over 1536MB
- Bit 11-13: Cluster hardware level
- Bit 14-15: Cache/NVS hardware level

When the bit 0 = 1,

- Bit 1: Not used
- Bit 2-3: Failed storage path
- Bit 4-7: Number of channels per cluster
 - 0000 : Parallel channel = 4, serial channel = 0
 - 0001 : Parallel channel = 8, serial channel = 0
 - 0010 : Parallel channel = 4, serial channel = 2
 - 0100 : Parallel channel = 4, serial channel = 4
 - 0110 : Parallel channel = 0, serial channel = 2
 - 1000 : Parallel channel = 0, serial channel = 4
 - 1010 : Parallel channel = 0, serial channel = 8
 - 1100 : Parallel channel = 0, serial channel = 6
- Bit 8: Dual frame
 - 0 : Dual frame
 - 1 : Modular power
- Bit 9-11: Cache size
 - 000 : Non cache
 - 001 : 256MB
 - 010 : 512MB
 - 011 : 768MB
 - 100 : 1024MB
 - 101 : 1280MB
 - 110 : 1536MB
 - 111 : Over 1536MB
- Bit 12-13: Cluster hardware level
- Bit 14-15: Cache/NVS hardware level

Format 0, Message A (LCP & overrun, bus out parity check)

	0	1	2	3	4	5	6	7	
7	Format (x'0')				Message (x'A')				
8	Command code								
9	Cylinder address								
10	Cylinder address								
11	Head address								
12	Record No.								
13	SSID of mate subsystem								
14	(x'0000' for EDCC)								
15	Manufacturer code ('000000')						Factory code ('00')		
16	Module ID								
17	Routine ID								
18	Processor No. CHA(0-7)				BBF OVER (XR4B)	PND OVER (XR4B)	STOP (XR49)	OVER (XR4A)	
19	Not used								
20	SSID of self subsystem								
21	SSID of self subsystem								
22	Symptom code (x'0F0A')								
23	Symptom code (x'0F0A')								

Format 1, Message 0 (Intervention required)

	0	1	2	3	4	5	6	7
7	Format (x'1')				Message (x'0')			
8	Ready	Enable	SSB PEND	Not used ('00000')				
9	Not used							
10	M.M.RSV	PIN VOL	Not used ('000000')					
11	Host type	DKC type	Not used ('00')		DKU type			
12	Module ID							
13	Routine ID							
14	Command code							
15	Not used (x'00')							
16	Not used (x'00')							
17	Not used (x'00')							
18	Processor number				Not used (x'0')			
19	Not used (x'00')							
20	SSID of self subsystem							
21	SSID of self subsystem							
22	Symptom code (x'9F10')							
23	Symptom code (x'9F10')							

Format 1, Message X (Drive report error)

	0	1	2	3	4	5	6	7
7	Format (x'1')				Message (x'2/4')			
8	Additional sense code + Additional sense code qualifier							
9	(See EC = E SSB for detail)							
10	SCSI Command code (See EC = E SSB for detail)							
11	Threshold type (See EC = E SSB for detail)							
12	Module ID							
13	Routine ID							
14	Not used (x'0')				DKA number			
15	CDEV number				RDEV number			
16	Type code ('000')			0	Sense key (See EC = E SSB for detail)			
17	Not used (x'00')							
18								
19								
20	SSID of self subsystem							
21	Symptom code (x'9F1X' X : Message)							
22								
23								

Format 3, Message F (reset allegiance)

	0	1	2	3	4	5	6	7
7	Format (x'3')				Message (x'F')			
8	Not used							
9	Activated LPN							
10	Device busy	ECI	Command chaining	Path reserve	Stack status	Wait sense	Long busy	Processor connect
11	Single path mode	Guarant path mode	MCB chaining	0	Block switch	0	0	0
12	Command code							
13	SSID of mate subsystem (x'0000' for EDCC)							
14								
15	Manufacturer code ('000000')						Factory code ('00')	
16	Specific information (module ID, routine ID)							
17								
18	Processor No. CHA (0 - 7) DKA (8 - F)				Not used			
19	Not used							
20	SSID of self subsystem							
21	Symptom code (x'3F3F')							
22								
23								

Format 4, Message X (Data check)

	0	1	2	3	4	5	6	7
7	Format (x'4')				Message (x'X')			
8	Cylinder address							
9								
10	Head address							
11								
12	Record number							
13	Sector number							
14	Controller ID							
15	Not used (x'00')							
16								
17								
18	Processor number				Not used (x'0')			
19	Not used (x'00')							
20	Command code							
21	SSID of self subsystem (low order)							
22	Symptom code (x'4XYY' Note 1)							
23								

(Note 1) Symptom code

X : x'0' : Data check in HA field
 x'1' : Data check in C field
 x'2' : Data check in K field
 x'3' : Data check in D field
 x'5' : PA error

YY : x'80' : Correctable (Recovered)
 x'C0' : Uncorrectable

Format 6, Message X (Statistics)

	0	1	2	3	4	5	6	7
7	Format (x'6')				Message (x'X') (Note 1)			
8	Number of read or searched bytes							
9								
10								
11								
12								
13	Seek count							
14	Not used (x'00')							
15	Manufacture code ('000000')					Factory code ('00')		
16	Not used (x'00')							
17	DKC serial number							
18								
19								
20	SSID of self subsystem							
21	Symptom code (x'6FYX') (Note 2)							
22								
23								

(Note 1) X: Channel number when parallel channel is connected.
LCP number in cluster when serial channel is connected.

(Note 2) Y: 0 : Statistics or RRBL command
1 : Channel data overrun
X : See note 1.

Format 7, Message 4 (FPC report error)

	0	1	2	3	4	5	6	7
7	Format (x'7')				Message (x'4')			
8	Not use							
9	Not used							
10	SCSI command code (See EC = D SSB for detail)							
11	Threshold type (See EC = D SSB for detail)							
12	Module ID							
13	Routine ID							
14	CDEV number							
15	RDEV number							
16	Type code ('111')			0	Not used (x'0')			
17	Not used (x'00')							
18								
19								
20	SSID of self subsystem							
21								
22	Symptom code (x'DF74')							
23								

Format 8, Message 1 (shared memory failure)

	0	1	2	3	4	5	6	7
7	Format (x'8')				Message(x'1')			
8	Micro error	MPA error	Shared memory Side A error	Shared memory Side B error	A0 path error	A1 path error	B0 path error	B1 path error
9	Format No. Format No. : x'01': X0A access micro error & MPA internal error x'02': X1A access micro error & MPA internal error x'03': X0A access shared memory error x'04': X1A access shared memory error x'05': X0A access SHSN error x'06': X1A access SHSN error x'07': others error							
10	MPA:CHK3LOG1:B700 0078(b00-07) Micro SM access address							
11	MPA:CHK3LOG1:B700 0078(b10-17) Micro SM access address							
12	MPA:CHK3LOG1:B700 0078(b20-27) Micro SM access address							
13	MPA:CHK3LOG1:B700 0078(b30-37) Micro SM access address							
14	MPA: CHK3STS:B700 0108(b00-07)							
	XR send parity error	XR recv parity error	MPID unmatch	Access error	compare error	Resource lock mode/queue error	XR timeout	XR SEQ error
15	MPA: CHK3STS:B700 0108(b10-17)							
	A0 collect ANYERR	A1 collect ANYERR	B0 collect ANYERR	B1 collect ANYERR	A0 path error	A1 path error	B0 path error	B1 path error
16	MPA: CHK3STS:B700 0108 (b20-27)							
	A0 path timer error	A1 path timer error	B0 path timer error	B1 path timer error	A0 path send parity error	A1 path send parity error	B0 path send parity error	B1 path send parity error
17	MPA: CHK3STS:B700 0108 (b30-37)							
	A0 path recv parity error	A1 path recv parity error	B0 path recv parity error	B1 path recv parity error	A0 path no response	A1 path no response	B0 path no response	B1 path no response
18	Not used							
19	Not used							
20	PCB No.				Message code: x'0'			
21	SSID (low order)							
22	Symptom code (x'FF81' : LDEV type = 6587)							
23	(x'EF81' : LDEV type = 6586)							

Format 8, Message 1 (CHK3 Reset)

	0	1	2	3	4	5	6	7
7	Format (x'8')				Message (x'1')			
8	Related failure internal SSB log No. (Error procedure aid)							
9								
10	Not used (x'00')							
11								
12	OLD PSW (interruption source address)							
13								
14								
15								
16	Internal SSB log No. (reset)							
17								
18	Detail log number for RESET							
19								
20	PCB number				Message code (x'3') (Note)			
21	SSID (lower order) of self subsystem							
22	Symptom code (x'FF81':LDEV type=DKU87I / x'EF81':LDEV type=DKU86I)							
23								

(Note) Indicates the 'CHK3 Reset'.

Format 8, Message 8 (LCP failure) (Note)

	0	1	2	3	4	5	6	7
7	Format (x'8')				Message (x'8')			
8	LCP error message (x'01': LCP CHK-2/adapter interface error)							
9	LCP error code							
10								
11	XR4B(H)							
	BBF OVERRUN	PND OVERRUN	0	0	0	0	0	0
12	XR4B(L)							
	LRCA ERR	LRCB ERR	BBFP PER	BBIP PER	BBOP PER	PND CK2	CNT PER	REQ CNT OVERRUN
13	XR3E(H)							
	RBFA APER	RBFB APER	RBFC APER	RBF WRDER	MBFA APER	MBFB APER	MBFC APER	MBF WRDER
14	XR3E(L)							
	FRM RCTPE	CMP DPER	XFR CHRPER	XFR SEQPER	M-CNT PER	H-CNT PER	0	0
15	XR55(H)							
	BUSPE PA	LRCER PA	REQ ER A	ADTDT ER A	0	0	0	0
16	XR55(L)							
	BUSPE PB	LRCER PB	REQ ER B	ADTDT ER B	0	0	0	0
17	Control flag							
	0	0	STOP (XR49:bit15)	CK2 DTX (XR4A:bit0)	CK2 LIN (XR4A:bit1)	IFERA (XR51:bit12)	IFERB (XR51:bit13)	
18	Module ID							
19	Routine ID							
20	Processor No.				Message code: x'A' (Note)			
21	SSID (low order)							
22	Symptom code (high order) (x'FF':LDEV type=DKU87I / x'EF':LDEV type=DKU86I)							
23	Symptom code (low order) (x'88')							

(Note): Indicates LCP failure when SSB7 = 88 and SSB20:b4-7 = A.

Format 8, Message 8 (LCP failure) (Note)

	0	1	2	3	4	5	6	7
7	Format (x'8')				Message (x'8')			
8	LCP error message (x'02': Link reception error)							
9	LCP error code							
10								
11	XR36(H)							
	L-SIG ERR0	L-SIG ERR1	CONN ERR0	CONN ERR1	CONN ERR2	0	0	0
12	XR37(H)							
	CONN ERR3	L-SIG ERR	CODE VIORA	SEQ ERR	CRC ERR	ABORT ERR	PROT ERR0	PROT ERR1
13	XR37(L)							
	PROT ERR2	PROT ERR3	PROT ERR4	PROT ERR5	PROT ERR6	PROT ERR7	PROT ERR8	PROT ERR9
14	XR33(H)							
	C-SOF ERR	P-SOF ERR	D-EOF ERR	P-EOF ERR	L-SIG ERR	CODE VIOLA	SEQ ERR	CRC ERR
15	XR33(L)							
	0	0	0	R-CNT 0	R-CNT 1	R-CNT 2	R-CNT 3	R-CNT 4
16	0	0	STOP (XR49:bit15)	ABORT (XR32:bit11)	ER RCV1 (XR4A:bit3)	ER RCV2 (XR4A:bit4)	ER RCV3 (XR4A:bit5)	OTHER (XR51:bit6)
17	XR2A(L)							
	Field Information							
18	Module ID							
19	Routine ID							
20	Processor No.				Message code: x'A' (Note)			
21	SSID (low order)							
22	Symptom code (high order) (x'FF':LDEV type=DKU87I / x'EF':LDEV type=DKU86I)							
23	Symptom code (low order) (x'88')							

(Note): Indicates LCP failure when SSB7 = 88 and SSB20:b4-7 = A.

Format 8, Message 8 (LCP failure) (Note)

	0	1	2	3	4	5	6	7
7	Format (x'8')				Message (x'8')			
8	LCP error message (x'0C': CHL data > DEV data at writing)							
9	LCP error code							
10								
11								
12	Request count							
13	Number of data received							
14								
15								
16	Not used (x'00')							
17								
18								
19	Module ID							
19	Routine ID							
20	Processor No.				Message code: x'A' (Note)			
21	SSID (low order)							
22	Symptom code (high order) (x'FF':LDEV type=DKU87I / x'EF':LDEV type=DKU86I)							
23	Symptom code (low order) (x'88')							

(Note): Indicates LCP failure when SSB7 = 88 and SSB20:b4-7 = A.

Format 8, Message 8 (LCP failure) (Note 1)

	0	1	2	3	4	5	6	7
7	Format (x'8')				Message (x'8')			
8	LCP error message (x'0E':Timeout)							
9	LCP error code							
10								
11	Reason code (Note 2)							
12								
13	XR49(H)							
	ESYCN	END	RDYOK	RDYRCV	0	CMDFRM	ACPRSP	DATAXF
14	XR49(L)							
	XFREND	DEVEND	CNTFLG	EOF	CMPEQ	CMPGT	0	STOP
15	XR51(H)							
	CAL PA	CAL PB	RDY	P BSY	CALL	SELTD	CHK1	DCK1
16	XR51(L)							
	BFBSY	ATTN	0	0	IFERA	IFERB	PA BSY	PB BSY
17	XR48(H)							
	RUN BSY	RUN TRS	RUN ADP	DAR REQ MOD	XFSTOP	CDFLG	CMPA	CMPB
18	Module ID							
19	Routine ID							
20	Processor No.				Message code:x'A' (Note 1)			
21	SSID (low order)							
22	Symptom code (high order) (x'FF':LDEV type=DKU87I / x'EF':LDEV type=DKU86I)							
23	Symptom code (low order) (x'88')							

(Note1): Indicates LCP failure when SSB7 = 88 and SSB20:b4-7 = A.

(Note2): Reason code

- x'FF01' : (READ) Timeout in waiting for ACP CMD RSP
- x'FF02' : (READ) Timeout in waiting for frame header
- x'FF03' : (READ) Timeout in waiting for data frame
- x'FF04' : (READ) Timeout in waiting for end of data transfer
- x'FF05' : (READ) Timeout in waiting for data frame
- x'FF06' : (READ) Timeout in waiting for end of data transfer
- x'FF07' : (READ) Timeout in waiting for command frame
- x'FF08' : (READ) Timeout in waiting for DATA REQ
- x'FF09' : (READ) Timeout in waiting for status
- x'FFF1' : (WRITE) Timeout in waiting for ACP CMD RSP
- x'FFF2' : (WRITE) Timeout in waiting for first data
- x'FFF3' : (WRITE) Timeout in waiting for frame header
- x'FFF4' : (WRITE) Timeout in waiting for frame header
- x'FFF5' : (WRITE) Timeout in waiting for frame header
- x'FFF6' : (WRITE) Timeout in waiting for command frame
- x'FFF7' : (WRITE) Timeout in waiting for frame header
- x'FFF8' : (WRITE) Timeout in waiting for end of data transfer
- x'FFF9' : (WRITE) Timeout in waiting for status

Format 8, Message 8 (LCP failure) (Note1)

	0	1	2	3	4	5	6	7								
7	Format (x'8')				Message (x'8')											
8	LCP error message (except x'01'/x'02'/x'0C'/x'0E') (Note2)															
9	LCP error code															
10																
11																
12																
13																
14									Not used							
15																
16																
17																
18	Module ID															
19	Routine ID															
20	Processor No.				Message code: x'A' (Note)											
21	SSID (low order)															
22	Symptom code (high order) (x'FF':LDEV type=DKU87I / x'EF':LDEV type=DKU86I)															
23	Symptom code (low order) (x'88')															

(Note1): Indicates LCP failure when SSB7 = 88 and SSB20:b4-7 = A.

(Note2): LCP error message

- x'00' : No message
- x'08' : Transmission error
- x'09' : Protocol error
- x'0D' : Retry abort

Format 8, Message 8 (MCP failure) (Note)

	0	1	2	3	4	5	6	7
7	Format (x'8')				Message (x'8')			
8	MCP error message (x'01': MCP CHK-2/adapter interface error/bus-out parity error)							
9	MCP error code							
10								
11	XRBS(H)							
	XFR END	CHK2	ADP ER	BO PER	CHL OVERRUN	TRUNCA- TION	HALT I/O	FCE END
12	XRBS(L)							
	ABEND	CHL END	DEV END	0	0	0	0	0
13	XRCK20(H)							
	MOD ERR	CAER	BSI0ER	BSI1ER	MBFAAPER	MBFCAPER	MBFWDPE R	0
14	XRCK20(L)							
	SPC PER	CHC PER	PND C PER	PND OV- RUN	CBIDER	BSI0 PER	BSI1 PER	0
15	XRCK21(H)							
	BBFIPER	LRC AER	LRC BER	BBIPER	BBOPPER	TGOPER	CBOBPER	FLGMPER
16	XRCK21(L)							
	CBOBLER	TAGSEQER	PLSWER	PLSDER	0	0	0	0
17	XRIFER							
	BUSPE0	LRCER0	SEQER0	ADPER0	BUSPE1	LRCER1	SEQER1	ADPDER1
18	Module ID							
19	Routine ID							
20	Processor No.				Message code: x'B' (Note)			
21	SSID (low order)							
22	Symptom code (high order) (x'FF':LDEV type=DKU87I / x'EF':LDEV type=DKU86I)							
23	Symptom code (low order) (x'88')							

(Note): Indicates MCP failure when SSB7 = 88 and SSB20:b4-7 = B

Format 8, Message 8 (MCP failure) (Note)

	0	1	2	3	4	5	6	7
7	Format (x'8')				Message (x'8')			
8	MCP error message (x'0E': MCP timeout)							
9	MCP error code							
10								
11	Cause code (H)							
12	Cause code (L)							
13	XRBS(H)							
	XFR END	CHK2	ADP ER	BO PER	CHL OVERRUN	TRUNCA- TION	HALT I/O	FCE END
14	XRBS(L)							
	ABEND	CHL END	DEV END	0	0	0	0	0
15	XRASTS(H)							
	CALP0	CALP1	RDY	PBSY	CALL	SELTD	CHK1	DCK1
16	XRASTS(L)							
	BFBSY	ATTN	0	0	IFER0	IFER1	P0BSY	P1BSY
17	XRBC0(H)							
	ENBL CHL	EXEC CHL	0	INC MODE	CHMODE0	CHMODE1	0	0
18	Module ID							
19	Routine ID							
20	Processor No.				Message code: x'B' (Note)			
21	SSID (low order)							
22	Symptom code (high order) (x'FF':LDEV type=DKU87I / x'EF':LDEV type=DKU86I)							
23	Symptom code (low order) (x'88')							

(Note): Indicates MCP failure when SSB7 = 88 and SSB20:b4-7 = B.

Format 8, Message 8 (MCP failure) (Note)

	0	1	2	3	4	5	6	7
7	Format (x'8')				Message (x'8')			
8	MCP error message (x'80': burst failed)							
9	MCP error code							
10								
11	Not used (x'0000')							
12								
13	Not used (x'0000')							
14								
15	Not used (x'00')							
16								
17								
18	Module ID							
19	Routine ID							
20	Processor No.				Message code: x'B' (Note)			
21	SSID (low order)							
22	Symptom code (high order) (x'FF':LDEV type=DKU87I / x'EF':LDEV type=DKU86I)							
23	Symptom code (low order) (x'88')							

(Note): Indicates MCP failure when SSB7 = 88 and SSB20:b4-7 = B.

Format 8, Message 9 (ESCON I/F CHA CHK2 : XFR CHK2)

	0	1	2	3	4	5	6	7
7	Format (x'8')				Message (x'9')			
8	SubCode (x'00' : ESCON I/F CHA - XFR CHK2)							
9	CHA::XFS0							
	TRANSFER END	(RSV)	(RSV)	PFC STATUS	CHK2	CHK2A	CHK2B	CHK2C
10	CHA::XFS0							
	CHK2D	TRUNCATI ON	HALT I/O	SEARCH DASD= CPU	SEARCH DASD> CPU	SEARCH DASD< CPU	(RSV)	ABORT
11	CHA::XFS1							
	(RSV)	(RSV)	(RSV)	(RSV)	MICRO ABORT	HARD ABORT	Force CHK1	Force CHK2
12	CHA::XFS1							
	NEXT SEG ADR REG STATUS	(RSV)	(RSV)	(RSV)	(RSV)	NEXT SEG ADR WAIT	PFC ZERO	(RSV)
13	CHA::PDC							
	(RSV)	(RSV)	(RSV)	ENLPLTB 0:NORMAL 1:LIST XFR	(RSV)	(RSV)	(RSV)	(RSV)
14	CHA::XFC0							
	ENBL XFR	EXEC XFR	(RSV)	(RSV)	(RSV)	CBP PNT INC STOP	CACHE I/O MODE	SSD MODE
15	CHA::XFC0							
	Data Tarnsfer Path: 0:ESCON=>CACHE 2:ESCON=>CBUF 3:CBUF=>ESCON 4:CACHE=>ESCON 6:CACHE=>CBUF 7:CBUF=>ESCON 8:CACHE SEARCH 9:CBUF SEARCH B:CACHE COPY				U-MODE (504B SB FORMAT)	(RSV)	(RSV)	WR FBA MODE
16	CHA::XFC1							
	(RSV)	ABORT	(RSV)	(RSV)	(RSV)	(RSV)	(RSV)	(RSV)
17	Reserved							
	(RSV)	(RSV)	(RSV)	(RSV)	(RSV)	(RSV)	(RSV)	(RSV)
18	Module ID							
19	Routine ID							
20	PK ID				Message Code (x'0')			
21	SSID for Self Subsystem							
22	Symptom Code (x'FF89':LDEV Type=DKU87I / x'EF89': LDEV Type=DKU86I)							
23								

Format 8, Message 9 (ESCON I/F CHA CHK2 : Abnormal Cache Slot Status 1)

	0	1	2	3	4	5	6	7
7	Format (x'8')				Message (x'9')			
8	SubCode (x'01' : ESCON I/F CHA - Abnormal Cache Slot Status 1, (Note 1))							
9	Slot Status							
10								
11								
12								
13	WRITE in Progress	Make GAP	Execute ERASE	Update HA/R0	Update BM	(RSV)		
14	SubBlock Number for Ready Response to Transfer							
15	Start SubBlock Number for Incompletet Recode							
16	End SubBlock Number for Incompletet Recode							
17	Reserved							
18	Module ID (Note 2)							
19	Routine ID							
20	PK ID				Message Code (Not Used)			
21	SSID for Self Subsystem							
22	Symptom Code (x'FF89':LDEV Type=DKU87I / x'EF89': LDEV Type=DKU86I)							
23								

(Note 1) Module ID = x'55' : After synchronous destage, cache slot with dirty attribute has been detected.

Module ID ≠ x'55' : In internal seqrch or orientation process, incomplete subblock has been detected.

Format 8, Message 9 (ESCON I/F CHA CHK2 : Abnormal Cache Slot Status 2)

	0	1	2	3	4	5	6	7
7	Format (x'8')				Message (x'9')			
8	SubCode (x'02' : ESCON I/F CHA - Abnormal Cache Slot Status 2, (Note 1))							
9	Slot Status							
10								
11								
12								
13	WRITE in Progress	Make GAP	Execute ERASE	Update HA/R0	Update BM	(RSV)		
14	SubBlock Number for Ready Response to Transfer							
15	Start SubBlock Number for Processing Recode							
16	End SubBlock Number for Processing Recode							
17	Reserved							
18	Module ID (Note 2)							
19	Routine ID							
20	PK ID				Message Code (Not Used)			
21	SSID for Self Subsystem							
22	Symptom Code (x'FF89':LDEV Type=DKU87I / x'EF89': LDEV Type=DKU86I)							
23								

(Note 1) Cache ECC/LRC error has been detected in read side.

Format 8, Message 9 (ESCON I/F CHA CHK2 : XFR TIMEOUT)

	0	1	2	3	4	5	6	7
7	Format (x'8')				Message (x'9')			
8	SubCode (x'1F' : ESCON I/F CHA - XFR TIME OUT)							
9	CHA::XFS0							
	TRANSFER END	(RSV)	(RSV)	PFC STATUS	CHK2	CHK2A	CHK2B	CHK2C
10	CHA::XFS0							
	CHK2D	TRUNCATI ON	HALT I/O	SEARCH DASD= CPU	SEARCH DASD> CPU	SEARCH DASD< CPU	(RSV)	ABORT
11	CHA::XFS1							
	(RSV)	(RSV)	(RSV)	(RSV)	MICRO ABORT	HARD ABORT	Force CHK1	Force CHK2
12	CHA::XFS1							
	NEXT SEG ADR REG STATUS	(RSV)	(RSV)	(RSV)	(RSV)	NEXT SEG ADR WAIT	PFC ZERO	(RSV)
13	CHA::PDC							
	(RSV)	(RSV)	(RSV)	ENLPLTB 0:NORMAL 1:LIST XFR	(RSV)	(RSV)	(RSV)	(RSV)
14	CHA::XFC0							
	ENBL XFR	EXEC XFR	(RSV)	(RSV)	(RSV)	CBP PNT INC STOP	CACHE I/O MODE	SSD MODE
15	CHA::XFC0							
	Data Tarnsfer Path: 0:ESCON=>CACHE 2:ESCON=>CBUF 3:CBUF=>ESCON 4:CACHE=>ESCON 6:CACHE=>CBUF 7:CBUF=>ESCON 8:CACHE SEARCH 9:CBUF SEARCH B:CACHE COPY				U-MODE (504B SB FORMAT)	(RSV)	(RSV)	WR FBA MODE
16	CHA::XFC1							
	(RSV)	ABORT	(RSV)	(RSV)	(RSV)	(RSV)	(RSV)	(RSV)
17	Reserved							
	(RSV)	(RSV)	(RSV)	(RSV)	(RSV)	(RSV)	(RSV)	(RSV)
18	Module ID							
19	Routine ID							
20	PK ID				Message Code (x'0')			
21	SSID for Self Subsystem							
22	Symptom Code (x'FF89':LDEV Type=DKU87I / x'EF89': LDEV Type=DKU86I)							
23								

Format 8, Message 9 (FICON I/F CHA CHK2 : XFR CHK2)

	0	1	2	3	4	5	6	7
7	Format (x'8')				Message (x'9')			
8	SubCode (x'20' : FICON I/F CHA - XFR CHK2)							
9	CHA::XFS0							
	TRANSFER END	(RSV)	(RSV)	PFC STATUS	CHK2	CHK2A	CHK2B	CHK2C
10	CHA::XFS0							
	CHK2D	TRUNCATI ON	HALT I/O	SEARCH DASD= CPU	SEARCH DASD> CPU	SEARCH DASD< CPU	(RSV)	ABORT
11	CHA::XFS1							
	(RSV)	(RSV)	(RSV)	(RSV)	MICRO ABORT	HARD ABORT	Force CHK1	Force CHK2
12	CHA::XFS1							
	NEXT SEG ADR REG STATUS	(RSV)	(RSV)	(RSV)	(RSV)	NEXT SEG ADR WAIT	PFC ZERO	(RSV)
13	CHA::DCTL							
	M128 FLG	RUN	READ FLG	ASYNC FLG	CNP FLG	CD FLG	COF	MSW FLG
14	CHA::XFC0							
	ENBL XFR	EXEC XFR	(RSV)	(RSV)	(RSV)	CBP PNT INC STOP	CACHE I/O MODE	SSD MODE
15	CHA::XFC0							
	Data Tarnsfer Path: 0:ESCON=>CACHE 2:ESCON=>CBUF 3:CBUF=>ESCON 4:CACHE=>ESCON 6:CACHE=>CBUF 7:CBUF=>ESCON 8:CACHE SEARCH 9:CBUF SEARCH B:CACHE COPY				U-MODE (504B SB FORMAT)	(RSV)	(RSV)	WR FBA MODE
16	CHA::XFC1							
	(RSV)	ABORT	(RSV)	(RSV)	(RSV)	(RSV)	(RSV)	(RSV)
17	Reserved							
	(RSV)	(RSV)	(RSV)	(RSV)	(RSV)	(RSV)	(RSV)	(RSV)
18	Module ID							
19	Routine ID							
20	PK ID				Message Code (x'0')			
21	SSID for Self Subsystem							
22	Symptom Code (x'FF89':LDEV Type=DKU87I / x'EF89': LDEV Type=DKU86I)							
23								

Format 8, Message 9 (FICON I/F CHA CHK2 : XFR TIMEOUT)

	0	1	2	3	4	5	6	7
7	Format (x'8')				Message (x'9')			
8	SubCode (x'3F' : FICON I/F CHA - XFR TIME OUT)							
9	CHA::XFS0							
	TRANSFER END	(RSV)	(RSV)	PFC STATUS	CHK2	CHK2A	CHK2B	CHK2C
10	CHA::XFS0							
	CHK2D	TRUNCATI ON	HALT I/O	SEARCH DASD= CPU	SEARCH DASD> CPU	SEARCH DASD< CPU	(RSV)	ABORT
11	CHA::XFS1							
	(RSV)	(RSV)	(RSV)	(RSV)	MICRO ABORT	HARD ABORT	Force CHK1	Force CHK2
12	CHA::XFS1							
	NEXT SEG ADR REG STATUS	(RSV)	(RSV)	(RSV)	(RSV)	NEXT SEG ADR WAIT	PFC ZERO	(RSV)
13	CHA::DCTL							
	M128 FLG	RUN	READ FLG	ASYNC FLG	CNP FLG	CD FLG	COF	MSW FLG
14	CHA::XFC0							
	ENBL XFR	EXEC XFR	(RSV)	(RSV)	(RSV)	CBP PNT INC STOP	CACHE I/O MODE	SSD MODE
15	CHA::XFC0							
	Data Tarnsfer Path: 0:ESCON=>CACHE 2:ESCON=>CBUF 3:CBUF=>ESCON 4:CACHE=>ESCON 6:CACHE=>CBUF 7:CBUF=>ESCON 8:CACHE SEARCH 9:CBUF SEARCH B:CACHE COPY				U-MODE (504B SB FORMAT)	(RSV)	(RSV)	WR FBA MODE
16	CHA::XFC1							
	(RSV)	ABORT	(RSV)	(RSV)	(RSV)	(RSV)	(RSV)	(RSV)
17	Reserved							
	(RSV)	(RSV)	(RSV)	(RSV)	(RSV)	(RSV)	(RSV)	(RSV)
18	Module ID							
19	Routine ID							
20	PK ID				Message Code (x'0')			
21	SSID for Self Subsystem							
22	Symptom Code (x'FF89':LDEV Type=DKU87I / x'EF89': LDEV Type=DKU86I)							
23								

Format 8, Message 9 (NAS I/F CHA CHK2)

	0	1	2	3	4	5	6	7
7	Format (x'8')				Message (x'9')			
8	SubCode (x'60' - x'6F' : NAS I/F CHA - DMA CHK2 (Note 1))							
9	NDTM::XFC							
	XFR Mode: '00':XFR Initialize '10':XFR Abort '11':XFR Start	CRC Mode: '00':No CRC '10':CRC Calculate (Cont.) '11':CRC Calculate (New)		(RSV)	(RSV)	INT Mode 0: Enable 1: Disable		(RSV)
10	NDTM::XFC							
	Data XFR Path: 0: PCI=>CACHE, 1: PCI=>CACHE(2SLV) 2: DBF=>CACHE, 3: DBF=>CACHE(2SLV) 6: CACHE FORMAT, 7: CACHE FORMAT(2SLV) 8: CACHE=>PCI, 9: CACHE=>DBF C: CtoC COPY D: CinC COPY			PCI Mode: 0: Master 1: Target	PBF Mode: 0: No Fetch 1: Fetch	(RSV)	(RSV)	
11	NDTM::XFC							
	CHSN Data Format: '00': Sub-Block '10': I/O, no SLRC '11': I/O, with LRC	(RSV)	(RSV)	(RSV)	SLRC CHK: 0: Enable 1: Disable	SP Mode: 0: Normal 1: SP ACS	DIAG Mode: 0: Normal 1: DIAG ACS	
12	NDTM::XFC							
	REQID			PBF Chain: Chain Number= 1 ~ 32 (32: When Set as '0')				
13	XMPA::PnFINTS							
	(RSV)	(RSV)	Other DMA#0 XFR END	Other DMA#1 XFR END	Other DMA#2 XFR END	Other DMA#3 XFR END	Other DMA#4 XFR END	Other DMA#5 XFR END
14	XMPA::PnFINTS							
	(RSV)	(RSV)	Own DMA#0 XFR END	Own DMA#1 XFR END	Own DMA#2 XFR END	Own DMA#3 XFR END	Own DMA#4 XFR END	Own DMA#5 XFR END
15	XMPA::PnFINTS							
	(RSV)	(RSV)	Other DMA#0 CHK2AINT	Other DMA#1 CHK2AINT	Other DMA#2 CHK2AINT	Other DMA#3 CHK2AINT	Other DMA#4 CHK2AINT	Other DMA#5 CHK2AINT
16	XMPA::PnFINTS							
	(RSV)	(RSV)	Own DMA#0 CHK2AINT	Own DMA#1 CHK2AINT	Own DMA#2 CHK2AINT	Own DMA#3 CHK2AINT	Own DMA#4 CHK2AINT	Own DMA#5 CHK2AINT
17	Reserved							
	(RSV)	(RSV)	(RSV)	(RSV)	(RSV)	(RSV)	(RSV)	(RSV)
18	Module ID							
19	Routine ID							
20	PK ID				Message Code (x'0')			
21	SSID for Self Subsystem							
22	Symptom Code (x'FF89':LDEV Type=DKU87I / x'EF89': LDEV Type=DKU86I)							
23								

(Note 1) SubCode Bit 4: DMA# ('0':DMA#0/2, '1':DMA#1/3)
SubCode Bit 5: CHSN CHK2 detected
SubCode Bit 6: DMA CHK2 detected
SubCode Bit 7: PCI CHK2 detected

Format 8, Message 9 (FIBRE I/F CHA CHK2)

	0	1	2	3	4	5	6	7
7	Format (x'8')				Message (x'9')			
8	SubCode (x'80' - x'87' : FIBRE I/F CHA – DMA CHK2 (Note 1))							
9	FDTA::PnXFS							
	TRANSFER END	(RSV)	(RSV)	(RSV)	DMA CHK2B	DMA CHK2B	(RSV)	MP STOP0
10	FDTA::PnXFS							
	MP STOP1	PCI CHK2A	PCI CHK2B0	PCI CHK2B1	PCI CHK2B2	PCI OVER RUN	(RSV)	HSN CHK2
11	FDTA::PnXFS							
	(RSV)	P0 CHK2A	P0 CHK2B	P0 CHK2C	(RSV)	P0 CHK2A	P0 CHK2B	P0 CHK2C
12	FDTA::PnXFS							
	(RSV)	(RSV)	(RSV)	COMMON CHK2C	(RSV)	(RSV)	(RSV)	ABORT
13	FDTA::PnXFC							
	XFR BIT '00':XFR Initialize '10':XFR ABORT '11':XFR START	(RSV)	(RSV)	(RSV)	(RSV)	(RSV)	(RSV)	INT SEL 0:CHP SEL 1:FOP SEL
14	FDTA::PnXFC							
	(RSV)	(RSV)	(RSV)	(RSV)	(RSV)	XFR SEL '000':PCI DEVICE XFR '011':16B - 128B CACHE ACCESS		
15	FDTA::PnXFC							
	(RSV)	(RSV)	DATA FORMAT '00':528B FORMAT '10':16B-128B FORMAT		(RSV)	16 XFR CNT '000':16B ACCESS '011':64B ACCESS		
16	FDTA::PnXFC							
	(RSV)	(RSV)	XBF CHAIN (Transfer Chain Number :1 ~ 32)					
17	Reserved							
	(RSV)	(RSV)	(RSV)	(RSV)	(RSV)	(RSV)	(RSV)	(RSV)
18	Module ID							
19	Routine ID							
20	PK ID				Message Code (x'0')			
21	SSID for Self Subsystem							
22	Symptom Code (x'FF89':LDEV Type=DKU87I / x'EF89': LDEV Type=DKU86I)							
23								

(Note 1) SubCode Bit 5: CHSN CHK2 detected
SubCode Bit 6: DMA CHK2 detected
SubCode Bit 7: PCI CHK2 detected

Format 8, Message 9 (FIBRE I/F CHA CHK2)

	0	1	2	3	4	5	6	7
7	Format (x'8')				Message (x'9')			
8	SubCode (x'90' - x'97' : FIBRE I/F CHA – PMA CHK2 (Note 1))							
9	FDTA::PnXFS							
	TRANSFER END	(RSV)	(RSV)	(RSV)	PMA CHK2B	PMA CHK2B	(RSV)	MP STOP0
10	FDTA::PnXFS							
	MP STOP1	PCI CHK2A	PCI CHK2B0	PCI CHK2B1	PCI CHK2B2	PCI OVER RUN	(RSV)	HSN CHK2
11	FDTA::PnXFS							
	(RSV)	P0 CHK2A	P0 CHK2B	P0 CHK2C	(RSV)	P0 CHK2A	P0 CHK2B	P0 CHK2C
12	FDTA::PnXFS							
	(RSV)	(RSV)	(RSV)	COMMON CHK2C	(RSV)	(RSV)	(RSV)	ABORT
13	FDTA::PnXFC							
	XFR BIT '00':XFR Initialize '01':XFR ABORT '10':XFR START	(RSV)	(RSV)	(RSV)	(RSV)	(RSV)	(RSV)	INT SEL 0:CHP SEL 1:FOP SEL
14	FDTA::PnXFC							
	(RSV)	(RSV)	(RSV)	(RSV)	(RSV)	XFR SEL '010':DEBUG MODE CACHE ACCESS '011':16B - 64B CACHE ACCESS		
15	FDTA::PnXFC							
	(RSV)	(RSV)	DATA FORMAT '10':NO FLRC FORMAT '11':FLRC FORMAT		(RSV)	16 XFR CNT '000':16B ACCESS '011':64B ACCESS		
16	FDTA::PnXFC							
	(RSV)	(RSV)	(RSV)	(RSV)	(RSV)	(RSV)	(RSV)	(RSV)
17	Reserved							
	(RSV)	(RSV)	(RSV)	(RSV)	(RSV)	(RSV)	(RSV)	(RSV)
18	Module ID							
19	Routine ID							
20	PK ID				Message Code (x'0')			
21	SSID for Self Subsystem							
22	Symptom Code (x'FF89':LDEV Type=DKU87I / x'EF89': LDEV Type=DKU86I)							
23								

(Note 1) SubCode Bit 5: CHSN CHK2 detected
SubCode Bit 6: PMA CHK2 detected
SubCode Bit 7: PCI CHK2 detected

Format 8, Message A (FCA CHK2)

	0	1	2	3	4	5	6	7
7	Format (x'8')				Message (x'A')			
8	SubCode (Note1)							
9	MMC::RCVINT							
	SYSRST Interrupt Monitor	SELRST Interrupt Monitor	CHK1A Interrupt Monitor	CHK1B Interrupt Monitor	SMP Interrupt Monitor	LAN/SIO Interrupt Monitor	CHA/DRR Interrupt Monitor	ADP/SCA0 Interrupt Monitor
10	MMC::RCVINT							
	(RSV)	CHK3 Interrupt Monitor	(RSV)	SCA1 Interrupt Monitor	SCA2 Interrupt Monitor	SCA3 Interrupt Monitor	SCA4 Interrupt Monitor	SCA5 Interrupt Monitor
11	FCA::INTSTS							
	CHK2E ERR Interrupt	CHK2F ERR Interrupt	CHK2G ERR Interrupt	(RSV)	(RSV)	(RSV)	(RSV)	(RSV)
12	FCA::MODE							
	DRV→ CACHE XFR Start	CACHE→ DRV XFR Start	FSB→ CACHE XFR Start	CACHE→ FDB XFR Start	DRV→ FSB XFR Start	FDB→DRV XFR Start	(RSV)	(RSV)
13	FCA::MODE							
	Data/Parity (1: Data)	LA EX MODE	LA CHK MASK	LBA/LLRC CHK MASK	(RSV)	Subblock Length in Packet (MAX: 4)		
14	FCA::MODE							
	DMA QUE Number for the PDEV							
15	FCA::DMASTS							
	DMA END	(RSV)	INT5	INT4	INT3	INT2	INT1	INT0
16	FCA::DMASTS							
	CHK2E Occurred	CHK2F Occurred	CHK2G Occurred	(RSV)	CHK2RST	ABORT	PADDING	(RSV)
17	Reserved							
	(RSV)	(RSV)	(RSV)	(RSV)	(RSV)	(RSV)	(RSV)	(RSV)
18	Module ID							
19	Routine ID							
20	P/K ID				Message Code (x'0')			
21	SSID for Self Subsystem (Low)							
22	Symptom Code (x'FF8A':LDEV Type=DKU87I / x'EF8A':LDEV Type=DKU86I)							
23								

(Note 1) Meaning of SubCode:

x'10'= QDTA reported CHK2 when writing to cache,

x'11'= QDTA reported CHK2 when reading from cache,

x'20'= FCA CHK2 when writing to cache,

x'21'= FCA CHK2 when reading from cache,

x'30'= FCA-QDTA CHK2 when writing to cache,

x'31'= FCA-QDTA CHK2 when reading from cache,

x'40'= PCI CHK2 when writing to cache,

x'41'= PCI CHK2 when reading from cache,

x'60'= PCI-FCA CHK2 when writing to cache,

x'61'= PCI-FCA CHK2 when reading from cache,

x'48'= HDD CHK2 when writing to cache,

x'19'= CACHE CHK2 when reading from cache,

x'F0'= XFR TOV when writing to cache,

x'F1'= XFR TOV when reading from cache

Format 8, Message B (DRR CHK2)

	0	1	2	3	4	5	6	7
7	Format (x'8')				Message (x'B')			
8	SubCode (x'10' : DRR CHK2B - DRR DATA ERROR)							
9	DRR::STATS							
	CMD A Transfer End	(RSV)	CMD A Transfer Start	CMD A Transfer Excuting	CMD B Transfer End	(RSV)	CMD B Transfer Start	CMD B Transfer Excuting
10	DRR::STATS							
	CHK2 Detected	CHK2A Detected	CHK2B Detected	CHK2C Detected	CHK2D Detected	CHK1B Detected	Abort Detected	Force Err Detected
11	DRR::DRESTA2							
	P0 SEQ6 PARITY ERR	P1 SEQ6 PARITY ERR	SLRC CAL-DT PARITY ERR	SLRC DT PARITY ERR	AC PLRC-GEN DT PARITY ERR0	AC PLRC-GEN DT PARITY ERR1	DT PLRC-GEN DT PARITY ERR0	DT PLRC-GEN DT PARITY ERR1
12	DRR::DRESTA3							
	STATUS0 PLRC ERR	STATUS0 INV-PLRC ERR	STATUS1 PLRC ERR	STATUS1 INV-PLRC ERR	DT PLRC ERR	DT INV-PLRC ERR	DT END-CODE ERR	LA DT PARITY ERR
13	DRR::DRESTA3							
	DM0 DT0 PARITY ERR	DM0 DT1 PARITY ERR	DM0 DT2 PARITY ERR	DM0 DT3 PARITY ERR	DM0 DT4 PARITY ERR	DM0 DT5 PARITY ERR	DM0 DT6 PARITY ERR	DM0 DT7 PARITY ERR
14	DRR::DRESTA4							
	ELA/CLA DT PARITY ERR	CMD PARITY ERR AT64-CMD	STATUS0 END-CODE ERR	STATUS1 END-CODE ERR	SLAVE1 CMD-A ADR PARITY ERR	SLAVE1 CMD-B ADR PARITY ERR	SLAVE2 CMD-A ADR PARITY ERR	SLAVE2 CMD-B ADR PARITY ERR
15	DRR::DRESTA4							
	STATUS0 DT0 PARITY ERR	STATUS0 DT1 PARITY ERR	STATUS0 DT2 PARITY ERR	STATUS0 DT3 PARITY ERR	STATUS0 DT4 PARITY ERR	STATUS0 DT5 PARITY ERR	STATUS0 DT6 PARITY ERR	STATUS0 DT7 PARITY ERR
16	DRR::DRESTA5							
	STATUS1 DT0 PARITY ERR	STATUS1 DT1 PARITY ERR	STATUS1 DT2 PARITY ERR	STATUS1 DT3 PARITY ERR	STATUS1 DT4 PARITY ERR	STATUS1 DT5 PARITY ERR	STATUS1 DT6 PARITY ERR	STATUS1 DT7 PARITY ERR
17	DRR::DRESTA8							
	P0 ENT TIME OVER	P0 ACK TIME OVER	P1 ENT TIME OVER	P1 ACK TIME OVER	P0 USE FLAG	P1 USE FLAG	SLRC ERR	MRCF DOUBLE EXECUTE
18	Module ID							
19	Routine ID							
20	P/K ID				Message Code (x'0')			
21	SSID for Self Subsystem (Low)							
22	Symptom Code (x'FF8A':LDEV Type=DKU87I / x'EF8A':LDEV Type=DKU86I)							
23								

Format 8, Message B (DRR CHK2)

	0	1	2	3	4	5	6	7
7	Format (x'8')				Message (x'B')			
8	SubCode (x'11' : DRR CHK2B - CHSN0 DATA ERROR)							
9	DRR::STATS							
	CMD A Transfer End	(RSV)	CMD A Transfer Start	CMD A Transfer Excuting	CMD B Transfer End	(RSV)	CMD B Transfer Start	CMD B Transfer Excuting
10	DRR::STATS							
	CHK2 Detected	CHK2A Detected	CHK2B Detected	CHK2C Detected	CHK2D Detected	CHK1B Detected	Abort Detected	Force Err Detected
11	DRR::DRESTA5							
	P0 TX DT0 PARITY ERR	P0 TX DT1 PARITY ERR	P0 TX DT2 PARITY ERR	P0 TX DT3 PARITY ERR	P0 TX DT4 PARITY ERR	P0 TX DT5 PARITY ERR	P0 TX DT6 PARITY ERR	P0 TX DT7 PARITY ERR
12	DRR::DRESTA6							
	P0 RX DT0 PARITY ERR	P0 RX DT1 PARITY ERR	P0 RX DT2 PARITY ERR	P0 RX DT3 PARITY ERR	P0 RX DT4 PARITY ERR	P0 RX DT5 PARITY ERR	P0 RX DT6 PARITY ERR	P0 RX DT7 PARITY ERR
13	DRR::DRESTA6							
	P0 TXX I-DT0 PARITY ERR	P0 TXX I-DT1 PARITY ERR	P0 TXX O-DT0 PARITY ERR	P0 TXX O-DT1 PARITY ERR	P1 TXX I-DT0 PARITY ERR	P1 TXX I-DT1 PARITY ERR	P1 TXX O-DT0 PARITY ERR	P1 TXX O-DT1 PARITY ERR
14	DRR::DRESTAB							
	P0 AC PLRC ERR	P0 DT PLRC ERR	P0 STATUS0 PLRC ERR	P0 STATUS1 PLRC ERR	P0 AC PLRC-IV ERR	P0 DT PLRC-IV ERR	P0 STATUS0 PLRC-IV ERR	P0 STATUS1 PLRC-IV ERR
15	DRR::DRESTAB							
	P0 AC END CODE ERR	P0 DT END CODE ERR	P0 STATUS0 END CODE ERR	P0 STATUS1 END CODE ERR	P0 SLRC CHECK ERR	P0 SLRC CAL DT ERR	P0 SLRC RD DT ERR	P0 SBLK DCNT ERR
16	DRR::DRESTA8							
	LA0/LA1 COMP ERR	LA2 COMP ERR	SYND (ECC) ERR	DT END CODE ERR	P0 ERRINT	P1 ERRINT	STATUS0 CARB/CMA ERR	STATUS1 CARB/CMA ERR
17	DRR::DRESTA8							
	P0 ENT TIME OVER	P0 ACK TIME OVER	P1 ENT TIME OVER	P1 ACK TIME OVER	P0 USE FLAG	P1 USE FLAG	SLRC ERR	MRCF DOUBLE EXCUTE
18	Module ID							
19	Routine ID							
20	P/K ID				Message Code (x'0')			
21	SSID for Self Subsystem (Low)							
22	Symptom Code (x'FF8A':LDEV Type=DKU87I / x'EF8A':LDEV Type=DKU86I)							
23								

Format 8, Message B (DRR CHK2)

	0	1	2	3	4	5	6	7
7	Format (x'8')				Message (x'B')			
8	SubCode (x'12' : DRR CHK2B - CHSN1 DATA ERROR)							
9	DRR::STATS							
	CMD A Transfer End	(RSV)	CMD A Transfer Start	CMD A Transfer Excuting	CMD B Transfer End	(RSV)	CMD B Transfer Start	CMD B Transfer Excuting
10	DRR::STATS							
	CHK2 Detected	CHK2A Detected	CHK2B Detected	CHK2C Detected	CHK2D Detected	CHK1B Detected	Abort Detected	Force Err Detected
11	DRR::DRESTA6							
	P0 TXX I- DT0 PARITY ERR	P0 TXX I- DT1 PARITY ERR	P0 TXX O- DT0 PARITY ERR	P0 TXX O- DT1 PARITY ERR	P1 TXX I- DT0 PARITY ERR	P1 TXX I- DT1 PARITY ERR	P1 TXX O- DT0 PARITY ERR	P1 TXX O- DT1 PARITY ERR
12	DRR::DRESTA7							
	P1 TX DT0 PARITY ERR	P1 TX DT1 PARITY ERR	P1 TX DT2 PARITY ERR	P1 TX DT3 PARITY ERR	P1 TX DT4 PARITY ERR	P1 TX DT5 PARITY ERR	P1 TX DT6 PARITY ERR	P1 TX DT7 PARITY ERR
13	DRR::DRESTA7							
	P1 RX DT0 PARITY ERR	P1 RX DT1 PARITY ERR	P1 RX DT2 PARITY ERR	P1 RX DT3 PARITY ERR	P1 RX DT4 PARITY ERR	P1 RX DT5 PARITY ERR	P1 RX DT6 PARITY ERR	P1 RX DT7 PARITY ERR
14	DRR::DRESTAC							
	P1 AC PLRC ERR	P1 DT PLRC ERR	P1 STATUS0 PLRC ERR	P1 STATUS1 PLRC ERR	P1 AC PLRC-IV ERR	P1 DT PLRC-IV ERR	P1 STATUS0 PLRC-IV ERR	P1 STATUS1 PLRC-IV ERR
15	DRR::DRESTAC							
	P1 AC END CODE ERR	P1 DT END CODE ERR	P1 STATUS0 END CODE ERR	P1 STATUS1 END CODE ERR	P1 SLRC CHECK ERR	P1 SLRC CAL DT ERR	P1 SLRC RD DT ERR	P1 SBLK DCNT ERR
16	DRR::DRESTA8							
	LA0/LA1 COMP ERR	LA2 COMP ERR	SYND (ECC) ERR	DT END CODE ERR	P0 ERRINT	P1 ERRINT	STATUS0 CARB/ CMA ERR	STATUS1 CARB/ CMA ERR
17	DRR::DRESTA8							
	P0 ENT TIME OVER	P0 ACK TIME OVER	P1 ENT TIME OVER	P1 ACK TIME OVER	P0 USE FLAG	P1 USE FLAG	SLRC ERR	MRCF DOUBLE EXCUTE
18	Module ID							
19	Routine ID							
20	P/K ID				Message Code (x'0')			
21	SSID for Self Subsystem (Low)							
22	Symptom Code (x'FF8A':LDEV Type=DKU87I / x'EF8A':LDEV Type=DKU86I)							
23								

Format 8, Message B (DRR CHK2)

	0	1	2	3	4	5	6	7
7	Format (x'8')				Message (x'B')			
8	SubCode (x'13' : DRR CHK2B - DRR&CHSN0 DATA ERROR)							
9	DRR::STATS							
	CMD A Transfer End	(RSV)	CMD A Transfer Start	CMD A Transfer Excuting	CMD B Transfer End	(RSV)	CMD B Transfer Start	CMD B Transfer Excuting
10	DRR::STATS							
	CHK2 Detected	CHK2A Detected	CHK2B Detected	CHK2C Detected	CHK2D Detected	CHK1B Detected	Abort Detected	Force Err Detected
11	DRR::DRESTA2							
	P0 SEQ6 PARITY ERR	P1 SEQ6 PARITY ERR	SLRC CAL-DT PARITY ERR	SLRC DT PARITY ERR	AC PLRC-GEN DT PARITY ERR0	AC PLRC-GEN DT PARITY ERR1	DT PLRC-GEN DT PARITY ERR0	DT PLRC-GEN DT PARITY ERR1
12	DRR::DRESTA3							
	STATUS0 PLRC ERR	STATUS0 INV-PLRC ERR	STATUS1 PLRC ERR	STATUS1 INV-PLRC ERR	DT PLRC ERR	DT INV-PLRC ERR	DT END-CODE ERR	LA DT PARITY ERR
13	DRR::DRESTA3							
	DM0 DT0 PARITY ERR	DM0 DT1 PARITY ERR	DM0 DT2 PARITY ERR	DM0 DT3 PARITY ERR	DM0 DT4 PARITY ERR	DM0 DT5 PARITY ERR	DM0 DT6 PARITY ERR	DM0 DT7 PARITY ERR
14	DRR::DRESTA4							
	ELA/CLA DT PARITY ERR	CMD PARITY ERR AT64-CMD	STATUS0 END-CODE ERR	STATUS1 END-CODE ERR	SLAVE1 CMD-A ADR PARITY ERR	SLAVE1 CMD-B ADR PARITY ERR	SLAVE2 CMD-A ADR PARITY ERR	SLAVE2 CMD-B ADR PARITY ERR
15	DRR::DRESTA4							
	STATUS0 DT0 PARITY ERR	STATUS0 DT1 PARITY ERR	STATUS0 DT2 PARITY ERR	STATUS0 DT3 PARITY ERR	STATUS0 DT4 PARITY ERR	STATUS0 DT5 PARITY ERR	STATUS0 DT6 PARITY ERR	STATUS0 DT7 PARITY ERR
16	DRR::DRESTA5							
	STATUS1 DT0 PARITY ERR	STATUS1 DT1 PARITY ERR	STATUS1 DT2 PARITY ERR	STATUS1 DT3 PARITY ERR	STATUS1 DT4 PARITY ERR	STATUS1 DT5 PARITY ERR	STATUS1 DT6 PARITY ERR	STATUS1 DT7 PARITY ERR
17	DRR::DRESTA8							
	P0 ENT TIME OVER	P0 ACK TIME OVER	P1 ENT TIME OVER	P1 ACK TIME OVER	P0 USE FLAG	P1 USE FLAG	SLRC ERR	MRCF DOUBLE EXECUTE
18	Module ID							
19	Routine ID							
20	P/K ID				Message Code (x'0')			
21	SSID for Self Subsystem (Low)							
22	Symptom Code (x'FF8A':LDEV Type=DKU87I / x'EF8A':LDEV Type=DKU86I)							
23								

Format 8, Message B (DRR CHK2)

	0	1	2	3	4	5	6	7
7	Format (x'8')				Message (x'B')			
8	SubCode (x'14' : DRR CHK2B - DRR&CHSN1 DATA ERROR)							
9	DRR::STATS							
	CMD A Transfer End	(RSV)	CMD A Transfer Start	CMD A Transfer Excuting	CMD B Transfer End	(RSV)	CMD B Transfer Start	CMD B Transfer Excuting
10	DRR::STATS							
	CHK2 Detected	CHK2A Detected	CHK2B Detected	CHK2C Detected	CHK2D Detected	CHK1B Detected	Abort Detected	Force Err Detected
11	DRR::DRESTA2							
	P0 SEQ6 PARITY ERR	P1 SEQ6 PARITY ERR	SLRC CAL-DT PARITY ERR	SLRC DT PARITY ERR	AC PLRC-GEN DT PARITY ERR0	AC PLRC-GEN DT PARITY ERR1	DT PLRC-GEN DT PARITY ERR0	DT PLRC-GEN DT PARITY ERR1
12	DRR::DRESTA3							
	STATUS0 PLRC ERR	STATUS0 INV-PLRC ERR	STATUS1 PLRC ERR	STATUS1 INV-PLRC ERR	DT PLRC ERR	DT INV-PLRC ERR	DT END-CODE ERR	LA DT PARITY ERR
13	DRR::DRESTA3							
	DM0 DT0 PARITY ERR	DM0 DT1 PARITY ERR	DM0 DT2 PARITY ERR	DM0 DT3 PARITY ERR	DM0 DT4 PARITY ERR	DM0 DT5 PARITY ERR	DM0 DT6 PARITY ERR	DM0 DT7 PARITY ERR
14	DRR::DRESTA4							
	ELA/CLA DT PARITY ERR	CMD PARITY ERR AT64-CMD	STATUS0 END-CODE ERR	STATUS1 END-CODE ERR	SLAVE1 CMD-A ADR PARITY ERR	SLAVE1 CMD-B ADR PARITY ERR	SLAVE2 CMD-A ADR PARITY ERR	SLAVE2 CMD-B ADR PARITY ERR
15	DRR::DRESTA4							
	STATUS0 DT0 PARITY ERR	STATUS0 DT1 PARITY ERR	STATUS0 DT2 PARITY ERR	STATUS0 DT3 PARITY ERR	STATUS0 DT4 PARITY ERR	STATUS0 DT5 PARITY ERR	STATUS0 DT6 PARITY ERR	STATUS0 DT7 PARITY ERR
16	DRR::DRESTA5							
	STATUS1 DT0 PARITY ERR	STATUS1 DT1 PARITY ERR	STATUS1 DT2 PARITY ERR	STATUS1 DT3 PARITY ERR	STATUS1 DT4 PARITY ERR	STATUS1 DT5 PARITY ERR	STATUS1 DT6 PARITY ERR	STATUS1 DT7 PARITY ERR
17	DRR::DRESTA8							
	P0 ENT TIME OVER	P0 ACK TIME OVER	P1 ENT TIME OVER	P1 ACK TIME OVER	P0 USE FLAG	P1 USE FLAG	SLRC ERR	MRCF DOUBLE EXECUTE
18	Module ID							
19	Routine ID							
20	P/K ID				Message Code (x'0')			
21	SSID for Self Subsystem (Low)							
22	Symptom Code (x'FF8A':LDEV Type=DKU87I / x'EF8A':LDEV Type=DKU86I)							
23								

Format 8, Message B (DRR CHK2)

	0	1	2	3	4	5	6	7
7	Format (x'8')				Message (x'B')			
8	SubCode (x'20' : DRR CHK2B - DRR DATA ERROR2)							
9	DRR::STATS							
	CMD A Transfer End	(RSV)	CMD A Transfer Start	CMD A Transfer Excuting	CMD B Transfer End	(RSV)	CMD B Transfer Start	CMD B Transfer Excuting
10	DRR::STATS							
	CHK2 Detected	CHK2A Detected	CHK2B Detected	CHK2C Detected	CHK2D Detected	CHK1B Detected	Abort Detected	Force Err Detected
11	DRR::DRESTA2							
	P0 SEQ6 PARITY ERR	P1 SEQ6 PARITY ERR	SLRC CAL-DT PARITY ERR	SLRC DT PARITY ERR	AC PLRC-GEN DT PARITY ERR0	AC PLRC-GEN DT PARITY ERR1	DT PLRC-GEN DT PARITY ERR0	DT PLRC-GEN DT PARITY ERR1
12	DRR::DRESTA3							
	STATUS0 PLRC ERR	STATUS0 INV-PLRC ERR	STATUS1 PLRC ERR	STATUS1 INV-PLRC ERR	DT PLRC ERR	DT INV-PLRC ERR	DT END-CODE ERR	LA DT PARITY ERR
13	DRR::DRESTA3							
	DM0 DT0 PARITY ERR	DM0 DT1 PARITY ERR	DM0 DT2 PARITY ERR	DM0 DT3 PARITY ERR	DM0 DT4 PARITY ERR	DM0 DT5 PARITY ERR	DM0 DT6 PARITY ERR	DM0 DT7 PARITY ERR
14	DRR::DRESTA4							
	ELA/CLA DT PARITY ERR	CMD PARITY ERR AT64-CMD	STATUS0 END-CODE ERR	STATUS1 END-CODE ERR	SLAVE1 CMD-A ADR PARITY ERR	SLAVE1 CMD-B ADR PARITY ERR	SLAVE2 CMD-A ADR PARITY ERR	SLAVE2 CMD-B ADR PARITY ERR
15	DRR::DRESTA4							
	STATUS0 DT0 PARITY ERR	STATUS0 DT1 PARITY ERR	STATUS0 DT2 PARITY ERR	STATUS0 DT3 PARITY ERR	STATUS0 DT4 PARITY ERR	STATUS0 DT5 PARITY ERR	STATUS0 DT6 PARITY ERR	STATUS0 DT7 PARITY ERR
16	DRR::DRESTA5							
	STATUS1 DT0 PARITY ERR	STATUS1 DT1 PARITY ERR	STATUS1 DT2 PARITY ERR	STATUS1 DT3 PARITY ERR	STATUS1 DT4 PARITY ERR	STATUS1 DT5 PARITY ERR	STATUS1 DT6 PARITY ERR	STATUS1 DT7 PARITY ERR
17	DRR::DRESTA8							
	P0 ENT TIME OVER	P0 ACK TIME OVER	P1 ENT TIME OVER	P1 ACK TIME OVER	P0 USE FLAG	P1 USE FLAG	SLRC ERR	MRCF DOUBLE EXECUTE
18	Module ID							
19	Routine ID							
20	P/K ID				Message Code (x'0')			
21	SSID for Self Subsystem (Low)							
22	Symptom Code (x'FF8A':LDEV Type=DKU87I / x'EF8A':LDEV Type=DKU86I)							
23								

Format 8, Message B (DRR CHK2)

	0	1	2	3	4	5	6	7
7	Format (x'8')				Message (x'B')			
8	SubCode (x'30' : DRR CHK2A - DRR CTL ERROR)							
9	DRR::STATS							
	CMD A Transfer End	(RSV)	CMD A Transfer Start	CMD A Transfer Excuting	CMD B Transfer End	(RSV)	CMD B Transfer Start	CMD B Transfer Excuting
10	DRR::STATS							
	CHK2 Detected	CHK2A Detected	CHK2B Detected	CHK2C Detected	CHK2D Detected	CHK1B Detected	Abort Detected	Force Err Detected
11	DRR::DRERR							
	DRR CTL ERR	P0 CTL ERR	P1 CTL ERR	DRR DT ERR	P0 DT ERR	P1 DT ERR	STATUS0 CARB/CMA ERR	STATUS1 CARB/CMA ERR
12	DRR::DRESTA0							
	CMD A/B SEQ ERR	TRANS SEQ ERR	DRB-CBUF SEQ ERR	CBUF-DM0 SEQ ERR	DM0-BUFF SEQ ERR	CBUF-CHSN SEQ ERR	CBUF→PBUF WR-PNT PARITY ERR	CBUF→DM0 PK-CNT PARITY ERR
13	DRR::DRESTA0							
	DRB→CBUF PK-CNT PARITY ERR	CBUF→PBUF PK-CNT PARITY ERR	PBUF→CBUF PK-CNT PARITY ERR	TL CNT PARITY ERR	PL CNT PARITY ERR	TL/PL PRM ERR CMD A	TL/PL PRM ERR CMD B	DRB WT-ADR CNT PARITY ERR
14	DRR::DRESTA1							
	DRB RD-ADR CNT PARITY ERR	SB-BLK DT-CNT PARITY ERR	COBUF WT-ADR CNT PARITY ERR	COBUF RD-ADR CNT PARITY ERR	C1BUF WT-ADR CNT PARITY ERR	C1BUF RD-ADR CNT PARITY ERR	BMP0 DT PERR	BMP1 DT PERR
15	DRR::DRESTA1							
	P0 SYNC0 PNT PARITY ERR	P0 SYNC1 PNT PARITY ERR	P0 SYNC0 CLOCK PARITY ERR	P0 SYNC1 CLOCK PARITY ERR	P0 TX SEQ ERR	P0 TX RD PNT PARITY ERR	P0 RX SEQ ERR	P0 RX RD PNT PARITY ERR
16	DRR::DRESTA2							
	P1 SYNC0 PNT PARITY ERR	P1 SYNC1 PNT PARITY ERR	P1 SYNC0 CLOCK PARITY ERR	P1 SYNC1 CLOCK PARITY ERR	P1 TX SEQ ERR	P1 TX RD PNT PARITY ERR	P1 RX SEQ ERR	P1 RX RD PNT PARITY ERR
17	DRR::DRESTA2							
	P0 SEQ PARITY ERR	P1 SEQ PARITY ERR	SLRC CAL-DT PARITY ERR	SLRC DT PARITY ERR	AC PLRC-GEN DT PARITY ERR0	AC PLRC-GEN DT PARITY ERR1	DT PLRC-GEN DT PARITY ERR0	DT PLRC-GEN DT PARITY ERR1
18	Module ID							
19	Routine ID							
20	P/K ID				Message Code (x'0')			
21	SSID for Self Subsystem (Low)							
22	Symptom Code (x'FF8A':LDEV Type=DKU87I / x'EF8A':LDEV Type=DKU86I)							
23								

Format 8, Message B (DRR CHK2)

	0	1	2	3	4	5	6	7
7	Format (x'8')				Message (x'B')			
8	SubCode (x'40' : DRR CHK2D - ARBITER TIMER ERROR)							
9	DRR::DRESTA8							
	P0 ENT TIME OVER	P0 ACK TIME OVER	P1 ENT TIME OVER	P1 ACK TIME OVER	P0 USE FLAG	P1 USE FLAG	SLRC ERR	MRCF DOUBLE EXCUTE
10	DRR::P0ETM0 P0 ENT-TIMER (High)							
11	DRR::P0ETM0 P0 ENT-TIMER (High)							
12	DRR::P0ETM1 P0 ENT-TIMER (Low)							
13	DRR::P0ETM1 P0 ENT-TIMER (Low)							
14	DRR::P0ATM0 P0 ACK-TIMER (High)							
15	DRR::P0ATM0 P0 ACK-TIMER (High)							
16	DRR::P0ATM1 P0 ACK-TIMER (Low)							
17	DRR::P0ATM1 P0 ACK-TIMER (Low)							
18	Module ID							
19	Routine ID							
20	P/K ID				Message Code (x'0')			
21	SSID for Self Subsystem (Low)							
22	Symptom Code (x'FF8A':LDEV Type=DKU87I / x'EF8A':LDEV Type=DKU86I)							
23								

Format 8, Message B (DRR CHK2)

	0	1	2	3	4	5	6	7
7	Format (x'8')				Message (x'B')			
8	SubCode (x'A0' : DRR NO ERR - TIME OVER)							
9	DRR::STATS							
	CMD A Transfer End	(RSV)	CMD A Transfer Start	CMD A Transfer Excuting	CMD B Transfer End	(RSV)	CMD B Transfer Start	CMD B Transfer Excuting
10	DRR::STATS							
	CHK2 Detected	CHK2A Detected	CHK2B Detected	CHK2C Detected	CHK2D Detected	CHK1B Detected	Abort Detected	Force Err Detected
11	DRR::DRESTA2							
	P0 SEQ6 PARITY ERR	P1 SEQ6 PARITY ERR	SLRC CAL-DT PARITY ERR	SLRC DT PARITY ERR	AC PLRC-GEN DT PARITY ERR0	AC PLRC-GEN DT PARITY ERR1	DT PLRC-GEN DT PARITY ERR0	DT PLRC-GEN DT PARITY ERR1
12	DRR::DRESTA3							
	STATUS0 PLRC ERR	STATUS0 INV-PLRC ERR	STATUS1 PLRC ERR	STATUS1 INV-PLRC ERR	DT PLRC ERR	DT INV-PLRC ERR	DT END-CODE ERR	LA DT PARITY ERR
13	DRR::DRESTA3							
	DM0 DT0 PARITY ERR	DM0 DT1 PARITY ERR	DM0 DT2 PARITY ERR	DM0 DT3 PARITY ERR	DM0 DT4 PARITY ERR	DM0 DT5 PARITY ERR	DM0 DT6 PARITY ERR	DM0 DT7 PARITY ERR
14	DRR::DRESTA4							
	ELA/CLA DT PARITY ERR	CMD PARITY ERR AT64-CMD	STATUS0 END-CODE ERR	STATUS1 END-CODE ERR	SLAVE1 CMD-A ADR PARITY ERR	SLAVE1 CMD-B ADR PARITY ERR	SLAVE2 CMD-A ADR PARITY ERR	SLAVE2 CMD-B ADR PARITY ERR
15	DRR::DRESTA4							
	STATUS0 DT0 PARITY ERR	STATUS0 DT1 PARITY ERR	STATUS0 DT2 PARITY ERR	STATUS0 DT3 PARITY ERR	STATUS0 DT4 PARITY ERR	STATUS0 DT5 PARITY ERR	STATUS0 DT6 PARITY ERR	STATUS0 DT7 PARITY ERR
16	DRR::DRESTA5							
	STATUS1 DT0 PARITY ERR	STATUS1 DT1 PARITY ERR	STATUS1 DT2 PARITY ERR	STATUS1 DT3 PARITY ERR	STATUS1 DT4 PARITY ERR	STATUS1 DT5 PARITY ERR	STATUS1 DT6 PARITY ERR	STATUS1 DT7 PARITY ERR
17	DRR::DRESTA8							
	P0 ENT TIME OVER	P0 ACK TIME OVER	P1 ENT TIME OVER	P1 ACK TIME OVER	P0 USE FLAG	P1 USE FLAG	SLRC ERR	MRCF DOUBLE EXECUTE
18	Module ID							
19	Routine ID							
20	P/K ID				Message Code (x'0')			
21	SSID for Self Subsystem (Low)							
22	Symptom Code (x'FF8A':LDEV Type=DKU87I / x'EF8A':LDEV Type=DKU86I)							
23								

Format 8, Message B (DRR CHK2)

	0	1	2	3	4	5	6	7
7	Format (x'8')				Message (x'B')			
8	SubCode (x'B0' : DRR CHK2C)							
9	DRR::STATS							
	CMD A Transfer End	(RSV)	CMD A Transfer Start	CMD A Transfer Excuting	CMD B Transfer End	(RSV)	CMD B Transfer Start	CMD B Transfer Excuting
10	DRR::STATS							
	CHK2 Detected	CHK2A Detected	CHK2B Detected	CHK2C Detected	CHK2D Detected	CHK1B Detected	Abort Detected	Force Err Detected
11	DRR::DRESTA2							
	P0 SEQ6 PARITY ERR	P1 SEQ6 PARITY ERR	SLRC CAL- DT PARITY ERR	SLRC DT PARITY ERR	AC PLRC- GEN DT PARITY ERR0	AC PLRC- GEN DT PARITY ERR1	DT PLRC- GEN DT PARITY ERR0	DT PLRC- GEN DT PARITY ERR1
12	DRR::DRESTA3							
	STATUS0 PLRC ERR	STATUS0 INV-PLRC ERR	STATUS1 PLRC ERR	STATUS1 INV-PLRC ERR	DT PLRC ERR	DT INV-PLRC ERR	DT END-CODE ERR	LA DT PARITY ERR
13	DRR::DRESTA3							
	DM0 DT0 PARITY ERR	DM0 DT1 PARITY ERR	DM0 DT2 PARITY ERR	DM0 DT3 PARITY ERR	DM0 DT4 PARITY ERR	DM0 DT5 PARITY ERR	DM0 DT6 PARITY ERR	DM0 DT7 PARITY ERR
14	DRR::DRESTA4							
	ELA/CLA DT PARITY ERR	CMD PARITY ERR AT64- CMD	STATUS0 END-CODE ERR	STATUS1 END-CODE ERR	SLAVE1 CMD-A ADR PARITY ERR	SLAVE1 CMD-B ADR PARITY ERR	SLAVE2 CMD-A ADR PARITY ERR	SLAVE2 CMD-B ADR PARITY ERR
15	DRR::DRESTA4							
	STATUS0 DT0 PARITY ERR	STATUS0 DT1 PARITY ERR	STATUS0 DT2 PARITY ERR	STATUS0 DT3 PARITY ERR	STATUS0 DT4 PARITY ERR	STATUS0 DT5 PARITY ERR	STATUS0 DT6 PARITY ERR	STATUS0 DT7 PARITY ERR
16	DRR::DRESTA5							
	STATUS1 DT0 PARITY ERR	STATUS1 DT1 PARITY ERR	STATUS1 DT2 PARITY ERR	STATUS1 DT3 PARITY ERR	STATUS1 DT4 PARITY ERR	STATUS1 DT5 PARITY ERR	STATUS1 DT6 PARITY ERR	STATUS1 DT7 PARITY ERR
17	DRR::DRESTA8							
	P0 ENT TIME OVER	P0 ACK TIME OVER	P1 ENT TIME OVER	P1 ACK TIME OVER	P0 USE FLAG	P1 USE FLAG	SLRC ERR	MRCF DOUBLE EXCUTE
18	Module ID							
19	Routine ID							
20	P/K ID				Message Code (x'0')			
21	SSID for Self Subsystem (Low)							
22	Symptom Code (x'FF8A':LDEV Type=DKU87I / x'EF8A':LDEV Type=DKU86I)							
23								

Format 8, Message B (DRR CHK2)

	0	1	2	3	4	5	6	7
7	Format (x'8')				Message (x'B')			
8	SubCode (x'B1': P0 CHK2C)							
9	DRR::STATS							
	CMD A Transfer End	(RSV)	CMD A Transfer Start	CMD A Transfer Excuting	CMD B Transfer End	(RSV)	CMD B Transfer Start	CMD B Transfer Excuting
10	DRR::STATS							
	CHK2 Detected	CHK2A Detected	CHK2B Detected	CHK2C Detected	CHK2D Detected	CHK1B Detected	Abort Detected	Force Err Detected
11	DRR::DRESTA2							
	P0 SEQ6 PARITY ERR	P1 SEQ6 PARITY ERR	SLRC CAL- DT PARITY ERR	SLRC DT PARITY ERR	AC PLRC- GEN DT PARITY ERR0	AC PLRC- GEN DT PARITY ERR1	DT PLRC- GEN DT PARITY ERR0	DT PLRC- GEN DT PARITY ERR1
12	DRR::DRESTA3							
	STATUS0 PLRC ERR	STATUS0 INV-PLRC ERR	STATUS1 PLRC ERR	STATUS1 INV-PLRC ERR	DT PLRC ERR	DT INV-PLRC ERR	DT END-CODE ERR	LA DT PARITY ERR
13	DRR::DRESTA3							
	DM0 DT0 PARITY ERR	DM0 DT1 PARITY ERR	DM0 DT2 PARITY ERR	DM0 DT3 PARITY ERR	DM0 DT4 PARITY ERR	DM0 DT5 PARITY ERR	DM0 DT6 PARITY ERR	DM0 DT7 PARITY ERR
14	DRR::DRESTA4							
	ELA/CLA DT PARITY ERR	CMD PARITY ERR AT64- CMD	STATUS0 END-CODE ERR	STATUS1 END-CODE ERR	SLAVE1 CMD-A ADR PARITY ERR	SLAVE1 CMD-B ADR PARITY ERR	SLAVE2 CMD-A ADR PARITY ERR	SLAVE2 CMD-B ADR PARITY ERR
15	DRR::DRESTA4							
	STATUS0 DT0 PARITY ERR	STATUS0 DT1 PARITY ERR	STATUS0 DT2 PARITY ERR	STATUS0 DT3 PARITY ERR	STATUS0 DT4 PARITY ERR	STATUS0 DT5 PARITY ERR	STATUS0 DT6 PARITY ERR	STATUS0 DT7 PARITY ERR
16	DRR::DRESTA5							
	STATUS1 DT0 PARITY ERR	STATUS1 DT1 PARITY ERR	STATUS1 DT2 PARITY ERR	STATUS1 DT3 PARITY ERR	STATUS1 DT4 PARITY ERR	STATUS1 DT5 PARITY ERR	STATUS1 DT6 PARITY ERR	STATUS1 DT7 PARITY ERR
17	DRR::DRESTA8							
	P0 ENT TIME OVER	P0 ACK TIME OVER	P1 ENT TIME OVER	P1 ACK TIME OVER	P0 USE FLAG	P1 USE FLAG	SLRC ERR	MRCF DOUBLE EXCUTE
18	Module ID							
19	Routine ID							
20	P/K ID				Message Code (x'0')			
21	SSID for Self Subsystem (Low)							
22	Symptom Code (x'FF8A':LDEV Type=DKU87I / x'EF8A':LDEV Type=DKU86I)							
23								

Format 8, Message B (DRR CHK2)

	0	1	2	3	4	5	6	7
7	Format (x'8')				Message (x'B')			
8	SubCode (x'B2' : P1 CHK2C)							
9	DRR::STATS							
	CMD A Transfer End	(RSV)	CMD A Transfer Start	CMD A Transfer Excuting	CMD B Transfer End	(RSV)	CMD B Transfer Start	CMD B Transfer Excuting
10	DRR::STATS							
	CHK2 Detected	CHK2A Detected	CHK2B Detected	CHK2C Detected	CHK2D Detected	CHK1B Detected	Abort Detected	Force Err Detected
11	DRR::DRESTA2							
	P0 SEQ6 PARITY ERR	P1 SEQ6 PARITY ERR	SLRC CAL- DT PARITY ERR	SLRC DT PARITY ERR	AC PLRC- GEN DT PARITY ERR0	AC PLRC- GEN DT PARITY ERR1	DT PLRC- GEN DT PARITY ERR0	DT PLRC- GEN DT PARITY ERR1
12	DRR::DRESTA3							
	STATUS0 PLRC ERR	STATUS0 INV-PLRC ERR	STATUS1 PLRC ERR	STATUS1 INV-PLRC ERR	DT PLRC ERR	DT INV-PLRC ERR	DT END-CODE ERR	LA DT PARITY ERR
13	DRR::DRESTA3							
	DM0 DT0 PARITY ERR	DM0 DT1 PARITY ERR	DM0 DT2 PARITY ERR	DM0 DT3 PARITY ERR	DM0 DT4 PARITY ERR	DM0 DT5 PARITY ERR	DM0 DT6 PARITY ERR	DM0 DT7 PARITY ERR
14	DRR::DRESTA4							
	ELA/CLA DT PARITY ERR	CMD PARITY ERR AT64- CMD	STATUS0 END-CODE ERR	STATUS1 END-CODE ERR	SLAVE1 CMD-A ADR PARITY ERR	SLAVE1 CMD-B ADR PARITY ERR	SLAVE2 CMD-A ADR PARITY ERR	SLAVE2 CMD-B ADR PARITY ERR
15	DRR::DRESTA4							
	STATUS0 DT0 PARITY ERR	STATUS0 DT1 PARITY ERR	STATUS0 DT2 PARITY ERR	STATUS0 DT3 PARITY ERR	STATUS0 DT4 PARITY ERR	STATUS0 DT5 PARITY ERR	STATUS0 DT6 PARITY ERR	STATUS0 DT7 PARITY ERR
16	DRR::DRESTA5							
	STATUS1 DT0 PARITY ERR	STATUS1 DT1 PARITY ERR	STATUS1 DT2 PARITY ERR	STATUS1 DT3 PARITY ERR	STATUS1 DT4 PARITY ERR	STATUS1 DT5 PARITY ERR	STATUS1 DT6 PARITY ERR	STATUS1 DT7 PARITY ERR
17	DRR::DRESTA8							
	P0 ENT TIME OVER	P0 ACK TIME OVER	P1 ENT TIME OVER	P1 ACK TIME OVER	P0 USE FLAG	P1 USE FLAG	SLRC ERR	MRCF DOUBLE EXCUTE
18	Module ID							
19	Routine ID							
20	P/K ID				Message Code (x'0')			
21	SSID for Self Subsystem (Low)							
22	Symptom Code (x'FF8A':LDEV Type=DKU87I / x'EF8A':LDEV Type=DKU86I)							
23								

Format 8, Message D (DKU/HDU Power Failure)

	0	1	2	3	4	5	6	7
7	Format (x'8')				Message (x'D')			
8	SubCode (x'80' : DKU/HDU Power Failure)							
9	Failure detected PDEV 0x10 ~ 0x1F: Detected RDEV# 0xFF: Detected by self-check							
10	Power Status							
	FSW#7 STATUS	FSW#6 STATUS	FSW#5 STATUS	FSW#4 STATUS	FSW#3 STATUS	FSW#2 STATUS	FSW#1 STATUS	FSW#0 STATUS
11	Micro Information SM control area information							
12	Micro Information SM control area information							
13	Micro Information SM control area information							
14	Micro Information SM control area information							
15	Blocked HDU Bit Map							
	1 st DKU				2 nd DKU			
16	Blocked HDU Bit Map							
	3 rd DKU				(RSV)	(RSV)	(RSV)	(RSV)
17	Reserved							
	(RSV)	(RSV)	(RSV)	(RSV)	(RSV)	(RSV)	(RSV)	(RSV)
18	Module ID							
19	Routine ID							
20	P/K ID				Message Code (x'0')			
21	SSID for Self Subsystem (Low)							
22	Symptom Code (x'FF8A':LDEV Type=DKU87I / x'EF8A':LDEV Type=DKU86I)							
23								

Format 8, Message D (DKU/HDU Power Failure)

	0	1	2	3	4	5	6	7
7	Format (x'8')				Message (x'D')			
8	SubCode (x'90' : DKU/HDU Power Failure Recover)							
9	Reserved							
	(RSV)	(RSV)	(RSV)	(RSV)	(RSV)	(RSV)	(RSV)	(RSV)
10	Power Status							
	FSW#7 STATUS	FSW#6 STATUS	FSW#5 STATUS	FSW#4 STATUS	FSW#3 STATUS	FSW#2 STATUS	FSW#1 STATUS	FSW#0 STATUS
11	Micro Information							
	SM control area information							
12	Micro Information							
	SM control area information							
13	Micro Information							
	SM control area information							
14	Micro Information							
	SM control area information							
15	Recovered HDU Bit Map							
	1 st DKU				2 nd DKU			
16	Recovered HDU Bit Map							
	3 rd DKU				(RSV)	(RSV)	(RSV)	(RSV)
17	Reserved							
	(RSV)	(RSV)	(RSV)	(RSV)	(RSV)	(RSV)	(RSV)	(RSV)
18	Module ID							
19	Routine ID							
20	P/K ID				Message Code (x'0')			
21	SSID for Self Subsystem (Low)							
22	Symptom Code (x'FF8A':LDEV Type=DKU87I / x'EF8A':LDEV Type=DKU86I)							
23								

Format 8, Message E (processor failure: CHK1A)

	0	1	2	3	4	5	6	7
7	Format (x'8')				Message (x'E')			
8	Subcode x'20': DRAM hard error							
9	MMC::ERRSTS							
	Not used	Not used	Not used	Not used	Not used	WCHK1 occurred	CHK1B occurred	CHK1A occurred
10	MMC::C1WSTS							
	CHK1A occurred	WCHK1 occurred	CHK1A occurred in MPCHK	CHK1A occurred at RMC	CHK1A occurred at DRAM	WCHK1 occurred in MPCHK	WCHK1 by CHK1A in CHK1A	Micro-force WCHK1
11	MMC::DRAMCTRLERR							
	Not used	Not used	DRAM control signal RAMADR error	DRAM control signal CS error	DRAM control signal RAS error	DRAM control signal CAS error	DRAM control signal WE error	DRAM control signal DQM error
12	MMC::CHK1ASTS							
	Not used	Not used	Not used	Not used	Not used	Not used	Not used	Not used
13	MMC::CHK1ASTS							
	DATA CNTPE	Not used	Not used	Not used	Not used	Not used	Not used	IB WP ERR
14	MMC::CHK1ASTS							
	IB RP ERR	IB HIT ERR	IB WTBL ERR	IB CNL ERR	MEM SEQ ERR	MEM INIT ERR	Not used	MEM ADR ERR
15	MMC::CHK1ASTS							
	MPU UNCER	MMC FETCH UNCER	MPU WR PROT	MPU ADR OVER	Not used	Not used	OTHER WR PROT	OTHER ADR OVER
16	RMC::RMCC1ASTS							
	RMC INT0	RMC INT1	RMC INT2	RMC INT3	RMC INT4	RMC INT5	RMC INT6	RMC INT7
17	RMC::RMCC1BSTS							
	RMC INT0	RMC INT1	RMC INT2	RMC INT3	RMC INT4	RMC INT5	RMC INT6	RMC INT7
18	Module ID							
19	Routine ID							
20	Failed Processor No.				Message code (x'0')			
21	SSID (low order)							
22	Symptom code (x'FF8E' : LDEV type = DKU87I/x'EF8E' : LDEV type = DKU86I)							
23								

Format 8, Message E (processor failure: CHK1A)

	0	1	2	3	4	5	6	7
7	Format (x'8')				Message (x'E')			
8	Subcode x'21': RMC CHK1A error							
9	MMC::ERRSTS							
	Not used	Not used	Not used	Not used	Not used	WCHK1 occurred	CHK1B occurred	CHK1A occurred
10	MMC::C1WSTS							
	CHK1A occurred	WCHK1 occurred	CHK1A occurred in MPCHK	CHK1A occurred at RMC	CHK1A occurred at DRAM	WCHK1 occurred in MPCHK	WCHK1 by CHK1A in CHK1A	Micro-force WCHK1
11	MMC::DRAMCTRLERR							
	Not used	Not used	DRAM control signal RAMADR error	DRAM control signal CS error	DRAM control signal RAS error	DRAM control signal CAS error	DRAM control signal WE error	DRAM control signal DQM error
12	MMC::CHK1ASTS							
	Not used	Not used	Not used	Not used	Not used	Not used	Not used	Not used
13	MMC::CHK1ASTS							
	DATA CNTPE	Not used	Not used	Not used	Not used	Not used	Not used	IB WP ERR
14	MMC::CHK1ASTS							
	IB RP ERR	IB HIT ERR	IB WTBL ERR	IB CNL ERR	MEM SEQ ERR	MEM INIT ERR	Not used	MEM ADR ERR
15	MMC::CHK1ASTS							
	MPU UNCER	MMC FETCH UNCER	MPU WR PROT	MPU ADR OVER	Not used	Not used	OTHER WR PROT	OTHER ADR OVER
16	RMC::RMCC1ASTS							
	RMC INT0	RMC INT1	RMC INT2	RMC INT3	RMC INT4	RMC INT5	RMC INT6	RMC INT7
17	RMC::RMCC1BSTS							
	RMC INT0	RMC INT1	RMC INT2	RMC INT3	RMC INT4	RMC INT5	RMC INT6	RMC INT7
18	Module ID							
19	Routine ID							
20	Failed Processor No.				Message code (x'0')			
21	SSID (low order)							
22	Symptom code (x'FF8E' : LDEV type = DKU87I/x'EF8E' : LDEV type = DKU86I)							
23								

Format 8, Message E (processor failure: CHK1A)

	0	1	2	3	4	5	6	7
7	Format (x'8')				Message (x'E')			
8	Subcode x'30': DRAM CHK1A micro error							
9	MMC::ERRSTS							
	Not used	Not used	Not used	Not used	Not used	WCHK1 occurred	CHK1B occurred	CHK1A occurred
10	MMC::C1WSTS							
	CHK1A occurred	WCHK1 occurred	CHK1A occurred in MPCHK	CHK1A occurred at RMC	CHK1A occurred at DRAM	WCHK1 occurred in MPCHK	WCHK1 by CHK1A in CHK1A	Micro-force WCHK1
11	MMC::DRAMCTRLERR							
	Not used	Not used	DRAM control signal RAMADR error	DRAM control signal CS error	DRAM control signal RAS error	DRAM control signal CAS error	DRAM control signal WE error	DRAM control signal DQM error
12	MMC::CHK1ASTS							
	Not used	Not used	Not used	Not used	Not used	Not used	Not used	Not used
13	MMC::CHK1ASTS							
	DATA CNTPE	Not used	Not used	Not used	Not used	Not used	Not used	IB WP ERR
14	MMC::CHK1ASTS							
	IB RP ERR	IB HIT ERR	IB WTBL ERR	IB CNL ERR	MEM SEQ ERR	MEM INIT ERR	Not used	MEM ADR ERR
15	MMC::CHK1ASTS							
	MPU UNCER	MMC FETCH UNCER	MPU WR PROT	MPU ADR OVER	Not used	Not used	OTHER WR PROT	OTHER ADR OVER
16	RMC::RMCC1ASTS							
	RMC INT0	RMC INT1	RMC INT2	RMC INT3	RMC INT4	RMC INT5	RMC INT6	RMC INT7
17	RMC::RMCC1BSTS							
	RMC INT0	RMC INT1	RMC INT2	RMC INT3	RMC INT4	RMC INT5	RMC INT6	RMC INT7
18	Module ID							
19	Routine ID							
20	Failed Processor No.				Message code (x'0')			
21	SSID (low order)							
22	Symptom code (x'FF8E' : LDEV type = DKU87I/x'EF8E' : LDEV type = DKU86I)							
23								

Format 8, Message E (processor failure: CHK1A)

	0	1	2	3	4	5	6	7
7	Format (x'8')				Message (x'E')			
8	Subcode x'32': FETCH UNCORRECTABLE error							
9	MMC::ERRSTS							
	Not used	Not used	Not used	Not used	Not used	WCHK1 occurred	CHK1B occurred	CHK1A occurred
10	MMC::C1WSTS							
	CHK1A occurred	WCHK1 occurred	CHK1A occurred in MPCHK	CHK1A occurred at RMC	CHK1A occurred at DRAM	WCHK1 occurred in MPCHK	WCHK1 by CHK1A in CHK1A	Micro-force WCHK1
11	MMC::DRAMCTRLERR							
	Not used	Not used	DRAM control signal RAMADR error	DRAM control signal CS error	DRAM control signal RAS error	DRAM control signal CAS error	DRAM control signal WE error	DRAM control signal DQM error
12	MMC::CHK1ASTS							
	Not used	Not used	Not used	Not used	Not used	Not used	Not used	Not used
13	MMC::CHK1ASTS							
	DATA CNTPE	Not used	Not used	Not used	Not used	Not used	Not used	IB WP ERR
14	MMC::CHK1ASTS							
	IB RP ERR	IB HIT ERR	IB WTBL ERR	IB CNL ERR	MEM SEQ ERR	MEM INIT ERR	Not used	MEM ADR ERR
15	MMC::CHK1ASTS							
	MPU UNCER	MMC FETCH UNCER	MPU WR PROT	MPU ADR OVER	Not used	Not used	OTHER WR PROT	OTHER ADR OVER
16	RMC::RMCC1ASTS							
	RMC INT0	RMC INT1	RMC INT2	RMC INT3	RMC INT4	RMC INT5	RMC INT6	RMC INT7
17	RMC::RMCC1BSTS							
	RMC INT0	RMC INT1	RMC INT2	RMC INT3	RMC INT4	RMC INT5	RMC INT6	RMC INT7
18	Module ID							
19	Routine ID							
20	Failed Processor No.				Message code (x'0')			
21	SSID (low order)							
22	Symptom code (x'FF8E' : LDEV type = DKU87I/x'EF8E' : LDEV type = DKU86I)							
23								

Format 8, Message E (processor failure: CHA CHK1B)

	0	1	2	3	4	5	6	7
7	Format (x'8')				Message (x'E')			
8	Subcode x'40': MPA XR CHK1B							
9	MMC::CHK1BSTS							
	Not used	Not used	Not used	Not used	Not used	CHA CHK1B	MPA CHK1B	MMC CHK1B
10	MMC::CHK1BSTS							
	FCA CHK1B	DTA CHK1B	Not used	Not used	Not used	Not used	RMC CHK1B	DRAM CHK1B
11	MPA::MPASTS							
	MPAINT status bit	Master CHK3 occurred	Slave CHK3 occurred	Not used	PROM_IF CHK1B occurred	COM_IF CHK1B occurred	XR_IF CHK1B occurred	MPINT status bit
12	MPA::XWER							
	Access to not use address	Access to not use address	Access to not use address	Not used	Not used	Not used	Not used	XR byte access error
13	MPA::XWER							
	XR write address parity error				XR write data parity error			
	byte0	byte1	byte2	byte3	byte0	byte1	byte2	byte3
14	MPA::XRER							
	Not used	Not used	Not used	Not used	XR read data parity error			
					byte0	byte1	byte2	byte3
15	MMC::MICCHK1STS							
	Not used	Not used	Not used	Not used	Not used	Not used	XR decoder error (3B0)	XR decoder error (3B1)
16	MMC::MICCHK1STS							
	Not used	Not used	MP CHK counter parity error	Parity error in MMC internal bus	MP reset counter parity error	Hard timer parity error	Wait timer parity error	Hold timer parity error
17	MMC::MICCHK1STS							
	Not used	Wait time- out	XR decoder error (2A)	Not used	Not used	XR address parity error	Local bus data parity error	XR data parity error
18	Module ID							
19	Routine ID							
20	Failed Processor No.				Message code (x'0')			
21	SSID (low order)							
22	Symptom code (x'FF8E' : LDEV type = DKU87I/x'EF8E' : LDEV type = DKU86I)							
23								

Format 8, Message E (processor failure: CHA CHK1B)

	0	1	2	3	4	5	6	7
7	Format (x'8')				Message (x'E')			
8	Subcode x'41': FM CHK1B							
9	MMC::CHK1BSTS							
	Not used	Not used	Not used	Not used	Not used	CHA CHK1B	MPA CHK1B	MMC CHK1B
10	MMC::CHK1BSTS							
	FCA CHK1B	DTA CHK1B	Not used	Not used	Not used	Not used	RMC CHK1B	DRAM CHK1B
11	MPA::MPASTS							
	MPAINT status bit	Master CHK3 occurred	Slave CHK3 occurred	Not used	PROM_IF CHK1B occurred	COM_IF CHK1B occurred	XR_IF CHK1B occurred	MPINT status bit
12	MPA::XWER							
	Access to not use address	Access to not use address	Access to not use address	Not used	Not used	Not used	Not used	XR byte access error
13	MPA::XWER							
	XR write address parity error				XR write data parity error			
	byte0	byte1	byte2	byte3	byte0	byte1	byte2	byte3
14	MPA::XRER							
	Not used	Not used	Not used	Not used	XR read data parity error			
					byte0	byte1	byte2	byte3
15	MMC::MICCHK1STS							
	Not used	Not used	Not used	Not used	Not used	Not used	XR decoder error (3B0)	XR decoder error (3B1)
16	MMC::MICCHK1STS							
	Not used	Not used	MP CHK counter parity error	Parity error in MMC internal bus	MP reset counter parity error	Hard timer parity error	Wait timer parity error	Hold timer parity error
17	MMC::MICCHK1STS							
	Not used	Wait time- out	XR decoder error (2A)	Not used	Not used	XR address parity error	Local bus data parity error	XR data parity error
18	Module ID							
19	Routine ID							
20	Failed Processor No.				Message code (x'0')			
21	SSID (low order)							
22	Symptom code (x'FF8E' : LDEV type = DKU87I/x'EF8E' : LDEV type = DKU86I)							
23								

Format 8, Message E (processor failure: CHA CHK1B)

	0	1	2	3	4	5	6	7
7	Format (x'8')				Message (x'E')			
8	Subcode x'42': XPA CHK1B							
9	MMC::CHK1BSTS							
	Not used	Not used	Not used	Not used	Not used	CHA CHK1B	MPA CHK1B	MMC CHK1B
10	MMC::CHK1BSTS							
	FCA CHK1B	DTA CHK1B	Not used	Not used	Not used	Not used	RMC CHK1B	DRAM CHK1B
11	XPA:PNXERRO							
	Not used	PX read response count error	XR DMA access error	XR DMA count error	PX RD RSP timeout	XR DMA LRC error	WR address parity error	XR write date parity error
12	XPA:PNXERRO							
	Not used	Not used	PCI master address counter parity error	PCI master address parity error	PCI master SEQ error	PCI master read parity error	PCI master PERR in	PCI master PERR out
13	XPA:PNXERRO							
	Not used	PCI target100 address counter error	PCI target66 address counter error	PCI target SEQ error	Not used	PCI target read parity error	PCI target PERR in	PCI target PERR out
14	XPA:PNXERRO							
	XR TRG SEQ error	Not used	Not used	XR master address parity error	XR target cnt parity error	XR DMA read parity error	XR time over	XR read parity error
15	MMC::MICCHK1STS							
	Not used	Not used	Not used	Not used	Not used	Not used	XR decoder error (3B0)	XR decoder error (3B1)
16	MMC::MICCHK1STS							
	Not used	Not used	MP CHK counter parity error	Parity error in MMC internal bus	MP reset counter parity error	Hard timer parity error	Wait timer parity error	Hold timer parity error
17	MMC::MICCHK1STS							
	Not used	Wait time- out	XR decoder error (2A)	Not used	Not used	XR address parity error	Local bus data parity error	XR data parity error
18	Module ID							
19	Routine ID							
20	Failed Processor No.				Message code (x'0')			
21	SSID (low order)							
22	Symptom code (x'FF8E' : LDEV type = DKU87I/x'EF8E' : LDEV type = DKU86I)							
23								

Format 8, Message E (processor failure: CHA CHK1B)

	0	1	2	3	4	5	6	7
7	Format (x'8')				Message (x'E')			
8	Subcode x'43': ESCON/FICON CHK1B							
9	MMC::CHK1BSTS							
	Not used	Not used	Not used	Not used	Not used	CHA CHK1B	MPA CHK1B	MMC CHK1B
10	MMC::CHK1BSTS							
	FCA CHK1B	DTA CHK1B	Not used	Not used	Not used	Not used	RMC CHK1B	DRAM CHK1B
11	XLCM::CHK1B							
	IA0 parity error	Not used	IA2 parity error	IA3 parity error	ID0 parity error	ID1 parity error	ID2 parity error	ID3 parity error
12	XLCM::CHK1B							
	OD0 parity error	OD1 parity error	OD2 parity error	OD3 parity error	Not used	Not used	Not used	Not used
13	XLCM::CHK1B							
	CBF CHK1B	PL CHK1B	Not used	Not used	EXPTRUD	SRPTRUD	RIPTRUD	Not used
14	XLCM::CHK1B							
	SVCEXEC error	SCVP error	Not used	Not used	Not used	Not used	Not used	Not used
15	MMC::MICCHK1STS							
	Not used	Not used	Not used	Not used	Not used	Not used	XR decoder error (3B0)	XR decoder error (3B1)
16	MMC::MICCHK1STS							
	Not used	Not used	MP CHK counter parity error	Parity error in MMC internal bus	MP reset counter parity error	Hard timer parity error	Wait timer parity error	Hold timer parity error
17	MMC::MICCHK1STS							
	Not used	Wait time- out	XR decoder error (2A)	Not used	Not used	XR address parity error	Local bus data parity error	XR data parity error
18	Module ID							
19	Routine ID							
20	Failed Processor No.				Message code (x'0')			
21	SSID (low order)							
22	Symptom code (x'FF8E' : LDEV type = DKU87I/x'EF8E' : LDEV type = DKU86I)							
23								

Format 8, Message E (processor failure: CHA CHK1B)

	0	1	2	3	4	5	6	7
7	Format (x'8')				Message (x'E')			
8	Subcode x'44': MMC CHK1B							
9	MMC::CHK1BSTS							
	Not used	Not used	Not used	Not used	Not used	CHA CHK1B	MPA CHK1B	MMC CHK1B
10	MMC::CHK1BSTS							
	FCA CHK1B	DTA CHK1B	Not used	Not used	Not used	Not used	RMC CHK1B	DRAM CHK1B
11	MMC::MICCHK1STS							
	Not used	Not used	Not used	Not used	Not used	Not used	XR decoder error (3B0)	XR decoder error (3B1)
12	MMC::MICCHK1STS							
	Not used	Not used	MP CHK counter parity error	Parity error in MMC internal bus	MP reset counter parity error	Hard timer parity error	Wait timer parity error	Hold timer parity error
13	MMC::MICCHK1STS							
	Not used	Wait time- out	XR decoder error (2A)	Not used	Not used	XR address parity error	Local bus data parity error	XR data parity error
14	MMC::MPCERRSTS							
	Not used	Not used	WCHK1 at MPCHK	CHK1A at MPCHK	Timeout monitor timer parity error	A/B REG inconsistent check error	A/B REG write time- out	A/B REG access sequence error
15	MMC::MMCPERR							
	Not used	Not used	Not used	Not used	Data parity err in MMC <00-07>	Data parity err in MMC <10-17>	Data parity err in MMC <20-27>	Data parity err in MMC <30-37>
16	MMC::TIMERR							
	Timer 0 parity error	Timer 1 parity error	Timer 2 parity error	Timer 3 parity error	Timer 4 parity error	Timer 5 parity error	Timer 6 parity error	Timer7 parity error
17	MMC::LBUSPER							
	Not used	Not used	Not used	Not used	L bus data parity error <00-07>	L bus data parity error <10-17>	L bus data parity error <20-27>	L bus data parity error <30-37>
18	Module ID							
19	Routine ID							
20	Failed Processor No.				Message code (x'0')			
21	SSID (low order)							
22	Symptom code (x'FF8E' : LDEV type = DKU87I/x'EF8E' : LDEV type = DKU86I)							
23								

Format 8, Message E (processor failure: CHA CHK1B)

	0	1	2	3	4	5	6	7
7	Format (x'8')				Message (x'E')			
8	Subcode x'45': MMC DRAM CHK1B							
9	MMC::CHK1BSTS							
	Not used	Not used	Not used	Not used	Not used	CHA CHK1B	MPA CHK1B	MMC CHK1B
10	MMC::CHK1BSTS							
	FCA CHK1B	DTA CHK1B	Not used	Not used	Not used	Not used	RMC CHK1B	DRAM CHK1B
11	MMC::DRAMC1BSTS							
	MPU correctable error	MMC FETCH correctable error	MPU XR read incorrect	MPU XR write incorrect	Not used	Not used	Not used	Not used
12	MMC::DRAMC1BSTS							
	Other correctable error	Not used	Other uncorrectabl e error	Not used	Not used	Not used	Not used	Not used
13	MMC::DRAMC1BSTS							
	Not used	Refresh request timer error	Not used	Refresh time out	Not used	Not used	Not used	Not used
14	MMC::ERADR							
	Error address in LM							
15	MMC::ERADR							
	Error address in LM							
16	MMC::ERADR							
	Error address in LM							
17	MMC::ERADR							
	Error address in LM						Not used	Not used
18	Module ID							
19	Routine ID							
20	Failed Processor No.				Message code (x'0')			
21	SSID (low order)							
22	Symptom code (x'FF8E' : LDEV type = DKU871/x'EF8E' : LDEV type = DKU861)							
23								

Format 8, Message E (processor failure: CHA CHK1B)

	0	1	2	3	4	5	6	7
7	Format (x'8')				Message (x'E')			
8	Subcode x'46': MMC FETCH CHK1B							
9	MMC::CHK1BSTS							
	Not used	Not used	Not used	Not used	Not used	CHA CHK1B	MPA CHK1B	MMC CHK1B
10	MMC::CHK1BSTS							
	FCA CHK1B	DTA CHK1B	Not used	Not used	Not used	Not used	RMC CHK1B	DRAM CHK1B
11	MMC::DRAMC1BSTS							
	MPU correctable error	MMC FETCH correctable error	MPU XR read incorrect	MPU XR write incorrect	Not used	Not used	Not used	Not used
12	MMC::DRAMC1BSTS							
	Other correctable error	Not used	Other uncorrectabl e error	Not used	Not used	Not used	Not used	Not used
13	MMC::DRAMC1BSTS							
	Not used	Refresh request timer error	Not used	Refresh time out	Not used	Not used	Not used	Not used
14	MMC::FERADR							
	Error address in fetch to LM							
15	MMC::FERADR							
	Error address in fetch to LM							
16	MMC::FERADR							
	Error address in fetch to LM							
17	MMC::FERADR							
	Error address in fetch to LM						Not used	Not used
18	Module ID							
19	Routine ID							
20	Failed Processor No.				Message code (x'0')			
21	SSID (low order)							
22	Symptom code (x'FF8E' : LDEV type = DKU871/x'EF8E' : LDEV type = DKU861)							
23								

Format 8, Message E (processor failure: CHA CHK1B)

	0	1	2	3	4	5	6	7
7	Format (x'8')				Message (x'E')			
8	Subcode x'47':RMC CHK1B							
9	MMC::CHK1BSTS							
	Not used	Not used	Not used	Not used	Not used	CHA CHK1B	MPA CHK1B	MMC CHK1B
10	MMC::CHK1BSTS							
	FCA CHK1B	DTA CHK1B	Not used	Not used	Not used	Not used	RMC CHK1B	DRAM CHK1B
11	Not used							
12	MMC::ERADR							
	Error address in LM							
13	MMC::ERADR							
	Error address in LM							
14	MMC::ERADR							
	Error address in LM							
15	MMC::ERADR							
	Error address in LM						Not used	Not used
16	RMC::RMCC1ASTS							
	RMC INT0	RMC INT1	RMC INT2	RMC INT3	RMC INT4	RMC INT5	RMC INT6	RMC INT7
17	RMC::RMCC1BSTS							
	RMC INT0	RMC INT1	RMC INT2	RMC INT3	RMC INT4	RMC INT5	RMC INT6	RMC INT7
18	Module ID							
19	Routine ID							
20	Failed Processor No.				Message code (x'0')			
21	SSID (low order)							
22	Symptom code (x'FF8E' : LDEV type = DKU87I/x'EF8E' : LDEV type = DKU86I)							
23								

Format 8, Message E (processor failure: CHA CHK1B)

	0	1	2	3	4	5	6	7
7	Format (x'8')				Message (x'E')			
8	Subcode x'48': XMPA CHK1B							
9	MMC::CHK1BSTS							
	Not used	Not used	Not used	Not used	Not used	CHA CHK1B	MPA CHK1B	MMC CHK1B
10	MMC::CHK1BSTS							
	FCA CHK1B	DTA CHK1B	Not used	Not used	Not used	Not used	RMC CHK1B	DRAM CHK1B
11	XPA:PNXCK1B							
	PCI Config error	PX Read Response Count error	XR DMA Access error	XR DMA Count error	PX RD RSP timeout	XR DMA LCR error	XR address Parity error	XR write data parity error
12	XPA:PNXCK1B							
	Not used	Not used	Not used	Not used	Not used	NMI	IERR	SMBALER T
13	XPA:PNXCK1B							
	Not used	Not used	Not used	Not used	Not used	Not used	CMEN XR ECC2bit error	CMEM PCI ECC2bit error
14	XPA:PNISTAT							
	Not used	Not used	Not used	Not used	Not used	Not used	Not used	XPA error
15	MMC::MICCHK1STS							
	Not used	Not used	Not used	Not used	Not used	Not used	XR decoder error (3B0)	XR decoder error (3B1)
16	MMC::MICCHK1STS							
	Not used	Not used	MP CHK counter parity error	Parity error in MMC internal bus	MP reset counter parity error	Hard timer parity error	Wait timer parity error	Hold timer parity error
17	MMC::MICCHK1STS							
	Not used	Wait time- out	XR decoder error (2A)	Not used	Not used	XR address parity error	Local bus data parity error	XR data parity error
18	Module ID							
19	Routine ID							
20	Failed Processor No.				Message code (x'0')			
21	SSID (low order)							
22	Symptom code (x'FF8E' : LDEV type = DKU87I/x'EF8E' : LDEV type = DKU86I)							
23								

Format 8, Message E (processor failure: CHA CHK1B)

	0	1	2	3	4	5	6	7
7	Format (x'8')				Message (x'E')			
8	Subcode x'50': MPA CHK1B							
9	MMC::CHK1BSTS							
	Not used	Not used	Not used	Not used	Not used	CHA CHK1B	MPA CHK1B	MMC CHK1B
10	MMC::CHK1BSTS							
	FCA CHK1B	DTA CHK1B	Not used	Not used	Not used	Not used	RMC CHK1B	DRAM CHK1B
11	MPA::MPASTS							
	MPAINT status bit	Master CHK3 occurred	Slave CHK3 occurred	Not used	PROM_IF CHK1B occurred	COM_IF CHK1B occurred	XR_IF CHK1B occurred	MPINT status bit
12	MPA::XWER							
	Access to not use address	Access to not use address	Access to not use address	Not used	Not used	Not used	Not used	XR byte access error
13	MPA::XWER							
	XR write address parity error				XR write data parity error			
	byte0	byte1	byte2	byte3	byte0	byte1	byte2	byte3
14	MPA::XRER							
	Not used	Not used	Not used	Not used	XR read data parity error			
					byte0	byte1	byte2	byte3
15	MMC::MICCHK1STS							
	Not used	Not used	Not used	Not used	Not used	Not used	XR decoder error (3B0)	XR decoder error (3B1)
16	MMC::MICCHK1STS							
	Not used	Not used	MP CHK counter parity error	Parity error in MMC internal bus	MP reset counter parity error	Hard timer parity error	Wait timer parity error	Hold timer parity error
17	MMC::MICCHK1STS							
	Not used	Wait time- out	XR decoder error (2A)	Not used	Not used	XR address parity error	Local bus data parity error	XR data parity error
18	Module ID							
19	Routine ID							
20	Failed Processor No.				Message code (x'0')			
21	SSID (low order)							
22	Symptom code (x'FF8E' : LDEV type = DKU87I/x'EF8E' : LDEV type = DKU86I)							
23								

Format 8, Message E (processor failure: CHA CHK1B)

	0	1	2	3	4	5	6	7
7	Format (x'8')				Message (x'E')			
8	Subcode x'51': FM CHK1B							
9	MMC::CHK1BSTS							
	Not used	Not used	Not used	Not used	Not used	CHA CHK1B	MPA CHK1B	MMC CHK1B
10	MMC::CHK1BSTS							
	FCA CHK1B	DTA CHK1B	Not used	Not used	Not used	Not used	RMC CHK1B	DRAM CHK1B
11	MPA::MPASTS							
	MPAINT status bit	Master CHK3 occurred	Slave CHK3 occurred	Not used	PROM_IF CHK1B occurred	COM_IF CHK1B occurred	XR_IF CHK1B occurred	MPINT status bit
12	MPA::XWER							
	Access to not use address	Access to not use address	Access to not use address	Not used	Not used	Not used	Not used	XR byte access error
13	MPA::XWER							
	XR write address parity error				XR write data parity error			
	byte0	byte1	byte2	byte3	byte0	byte1	byte2	byte3
14	MPA::XRER							
	Not used	Not used	Not used	Not used	XR read data parity error			
					byte0	byte1	byte2	byte3
15	MMC::MICCHK1STS							
	Not used	Not used	Not used	Not used	Not used	Not used	XR decoder error (3B0)	XR decoder error (3B1)
16	MMC::MICCHK1STS							
	Not used	Not used	MP CHK counter parity error	Parity error in MMC internal bus	MP reset counter parity error	Hard timer parity error	Wait timer parity error	Hold timer parity error
17	MMC::MICCHK1STS							
	Not used	Wait time- out	XR decoder error (2A)	Not used	Not used	XR address parity error	Local bus data parity error	XR data parity error
18	Module ID							
19	Routine ID							
20	Failed Processor No.				Message code (x'0')			
21	SSID (low order)							
22	Symptom code (x'FF8E' : LDEV type = DKU87I/x'EF8E' : LDEV type = DKU86I)							
23								

Format 8, Message E (processor failure: CHA CHK1B)

	0	1	2	3	4	5	6	7
7	Format (x'8')				Message (x'E')			
8	Subcode x'54': MMC CHK1B							
9	MMC::CHK1BSTS							
	Not used	Not used	Not used	Not used	Not used	CHA CHK1B	MPA CHK1B	MMC CHK1B
10	MMC::CHK1BSTS							
	FCA CHK1B	DTA CHK1B	Not used	Not used	Not used	Not used	RMC CHK1B	DRAM CHK1B
11	MMC::MICCHK1STS							
	Not used	Not used	Not used	Not used	Not used	Not used	XR decoder error (3B0)	XR decoder error (3B1)
12	MMC::MICCHK1STS							
	Not used	Not used	MP CHK counter parity error	Parity error in MMC internal bus	MP reset counter parity error	Hard timer parity error	Wait timer parity error	Hold timer parity error
13	MMC::MICCHK1STS							
	Not used	Wait time- out	XR decoder error (2A)	Not used	Not used	XR address parity error	Local bus data parity error	XR data parity error
14	MMC::MPCERRSTS							
	Not used	Not used	WCHK1 at MPCHK	CHK1A at MPCHK	Timeout monitor timer parity error	A/B REG inconsistent check error	A/B REG write time- out	A/B REG access sequence error
15	MMC::MMCPERR							
	Not used	Not used	Not used	Not used	Data parity err in MMC <00-07>	Data parity err in MMC <10-17>	Data parity err in MMC <20-27>	Data parity err in MMC <30-37>
16	MMC::TIMERR							
	Timer 0 parity error	Timer 1 parity error	Timer 2 parity error	Timer 3 parity error	Timer 4 parity error	Timer 5 parity error	Timer 6 parity error	Timer 7 parity error
17	MMC::LBUSPER							
	Not used	Not used	Not used	Not used	L bus data parity error <00-07>	L bus data parity error <10-17>	L bus data parity error <20-27>	L bus data parity error <30-37>
18	Module ID							
19	Routine ID							
20	Failed Processor No.				Message code (x'0')			
21	SSID (low order)							
22	Symptom code (x'FF8E' : LDEV type = DKU87I/x'EF8E' : LDEV type = DKU86I)							
23								

Format 8, Message E (processor failure: CHA CHK1B)

	0	1	2	3	4	5	6	7
7	Format (x'8')				Message (x'E')			
8	Subcode x'55': MMC DRAM CHK1B							
9	MMC::CHK1BSTS							
	Not used	Not used	Not used	Not used	Not used	CHA CHK1B	MPA CHK1B	MMC CHK1B
10	MMC::CHK1BSTS							
	FCA CHK1B	DTA CHK1B	Not used	Not used	Not used	Not used	RMC CHK1B	DRAM CHK1B
11	MMC::DRAMC1BSTS							
	MPU correctable error	MMC FETCH correctable error	MPU XR read incorrect	MPU XR write incorrect	Not used	Not used	Not used	Not used
12	MMC::DRAMC1BSTS							
	Other correctable error	Not used	Other uncorrectabl e error	Not used	Not used	Not used	Not used	Not used
13	MMC::DRAMC1BSTS							
	Not used	Refresh request timer error	Not used	Refresh time out	Not used	Not used	Not used	Not used
14	MMC::ERADR							
	Error address in LM							
15	MMC::ERADR							
	Error address in LM							
16	MMC::ERADR							
	Error address in LM							
17	MMC::ERADR							
	Error address in LM						Not used	Not used
18	Module ID							
19	Routine ID							
20	Failed Processor No.				Message code (x'0')			
21	SSID (low order)							
22	Symptom code (x'FF8E' : LDEV type = DKU871/x'EF8E' : LDEV type = DKU861)							
23								

Format 8, Message E (processor failure: CHA CHK1B)

	0	1	2	3	4	5	6	7
7	Format (x'8')				Message (x'E')			
8	Subcode x'58': XMPA CHK1B							
9	MMC::CHK1BSTS							
	Not used	Not used	Not used	Not used	Not used	CHA CHK1B	MPA CHK1B	MMC CHK1B
10	MMC::CHK1BSTS							
	FCA CHK1B	DTA CHK1B	Not used	Not used	Not used	Not used	RMC CHK1B	DRAM CHK1B
11	XPA:PNXCK1B							
	PCI Config error	PX Read Response Count error	XR DMA Access error	XR DMA Count error	PX RD RSP timeout	XR DMA LCR error	XR address Parity error	XR write data parity error
12	XPA:PNXCK1B							
	Not used	Not used	Not used	Not used	Not used	NMI	IERR	SMBALER T
13	XPA:PNXCK1B							
	Not used	Not used	Not used	Not used	Not used	Not used	CMEN XR ECC2bit error	CMEM PCI ECC2bit error
14	XPA:PNISTAT							
	Not used	Not used	Not used	Not used	Not used	Not used	Not used	XPA error
15	MMC::MICCHK1STS							
	Not used	Not used	Not used	Not used	Not used	Not used	XR decoder error (3B0)	XR decoder error (3B1)
16	MMC::MICCHK1STS							
	Not used	Not used	MP CHK counter parity error	Parity error in MMC internal bus	MP reset counter parity error	Hard timer parity error	Wait timer parity error	Hold timer parity error
17	MMC::MICCHK1STS							
	Not used	Wait time- out	XR decoder error (2A)	Not used	Not used	XR address parity error	Local bus data parity error	XR data parity error
18	Module ID							
19	Routine ID							
20	Failed Processor No.				Message code (x'0')			
21	SSID (low order)							
22	Symptom code (x'FF8E' : LDEV type = DKU87I/x'EF8E' : LDEV type = DKU86I)							
23								

Format 8, Message E (processor failure: DKA CHK1B)

	0	1	2	3	4	5	6	7
7	Format (x'8')				Message (x'E')			
8	Subcode x'60': MPA CHK1B							
9	MMC::CHK1BSTS							
	Not used	Not used	Not used	Not used	Not used	CHA CHK1B	MPA CHK1B	MMC CHK1B
10	MMC::CHK1BSTS							
	FCA CHK1B	DTA CHK1B	Not used	Not used	Not used	Not used	RMC CHK1B	DRAM CHK1B
11	MPA::MPASTS							
	MPAINT status bit	Master CHK3 occurred	Slave CHK3 occurred	Not used	PROM_IF CHK1B occurred	COM_IF CHK1B occurred	XR_IF CHK1B occurred	MPINT status bit
12	MPA::XWER							
	Access to not use address	Access to not use address	Access to not use address	Not used	Not used	Not used	Not used	XR byte access error
13	MPA::XWER							
	XR write address parity error				XR write data parity error			
	byte0	byte1	byte2	byte3	byte0	byte1	byte2	byte3
14	MPA::XRER							
	Not used	Not used	Not used	Not used	XR read data parity error			
					byte0	byte1	byte2	byte3
15	MMC::MICCHK1STS							
	Not used	Not used	Not used	Not used	Not used	Not used	XR decoder error (3B0)	XR decoder error (3B1)
16	MMC::MICCHK1STS							
	Not used	Not used	MP CHK counter parity error	Parity error in MMC internal bus	MP reset counter parity error	Hard timer parity error	Wait timer parity error	Hold timer parity error
17	MMC::MICCHK1STS							
	Not used	Wait time- out	XR decoder error (2A)	Not used	Not used	XR address parity error	Local bus data parity error	XR data parity error
18	Module ID							
19	Routine ID							
20	Failed Processor No.				Message code (x'0')			
21	SSID (low order)							
22	Symptom code (x'FF8E' : LDEV type = DKU87I/x'EF8E' : LDEV type = DKU86I)							
23								

Format 8, Message E (processor failure: DKA CHK1B)

	0	1	2	3	4	5	6	7
7	Format (x'8')				Message (x'E')			
8	Subcode x'61': FM CHK1B							
9	MMC::CHK1BSTS							
	Not used	Not used	Not used	Not used	Not used	CHA CHK1B	MPA CHK1B	MMC CHK1B
10	MMC::CHK1BSTS							
	FCA CHK1B	DTA CHK1B	Not used	Not used	Not used	Not used	RMC CHK1B	DRAM CHK1B
11	MPA::MPASTS							
	MPAINT status bit	Master CHK3 occurred	Slave CHK3 occurred	Not used	PROM_IF CHK1B occurred	COM_IF CHK1B occurred	XR_IF CHK1B occurred	MPINT status bit
12	MPA::XWER							
	Access to not use address	Access to not use address	Access to not use address	Not used	Not used	Not used	Not used	XR byte access error
13	MPA::XWER							
	XR write address parity error				XR write data parity error			
	byte0	byte1	byte2	byte3	byte0	byte1	byte2	byte3
14	MPA::XRER							
	Not used	Not used	Not used	Not used	XR read data parity error			
					byte0	byte1	byte2	byte3
15	MMC::MICCHK1STS							
	Not used	Not used	Not used	Not used	Not used	Not used	XR decoder error (3B0)	XR decoder error (3B1)
16	MMC::MICCHK1STS							
	Not used	Not used	MP CHK counter parity error	Parity error in MMC internal bus	MP reset counter parity error	Hard timer parity error	Wait timer parity error	Hold timer parity error
17	MMC::MICCHK1STS							
	Not used	Wait time- out	XR decoder error (2A)	Not used	Not used	XR address parity error	Local bus data parity error	XR data parity error
18	Module ID							
19	Routine ID							
20	Failed Processor No.				Message code (x'0')			
21	SSID (low order)							
22	Symptom code (x'FF8E' : LDEV type = DKU87I/x'EF8E' : LDEV type = DKU86I)							
23								

Format 8, Message E (processor failure: DKA CHK1B)

	0	1	2	3	4	5	6	7
7	Format (x'8')				Message (x'E')			
8	Subcode x'62': FCA CHK1B							
9	MMC::CHK1BSTS							
	Not used	Not used	Not used	Not used	Not used	CHA CHK1B	MPA CHK1B	MMC CHK1B
10	MMC::CHK1BSTS							
	FCA CHK1B	DTA CHK1B	Not used	Not used	Not used	Not used	RMC CHK1B	DRAM CHK1B
11	FCA::FCHK10							
	XR read data parity error				33MHz clock error	25MHz clock error	SEQ10 error	SEQ19 error
	Byte0	Byte1	Byte2	Byte3				
12	FCA::FCHK10							
	TLM read data parity error	PCI S error	Not used	Diagnose CHK1 occurred	PCI Devsel timeout	PCI TLM read address counter parity error	PCI target abort	PCI target ready
13	FCA::FCHK10							
	XR address parity error				XR write data parity error			
	Byte0	Byte1	Byte2	Byte3	Byte0	Byte1	Byte2	Byte3
14	FCA::FCHK10							
	TLM address counter parity error	ELM write address counter parity error	Not used	Not used	Not used	Not used	Not used	Not used
15	MMC::MICCHK1STS							
	Not used	Not used	Not used	Not used	Not used	Not used	XR decoder error (3B0)	XR decoder error (3B1)
16	MMC::MICCHK1STS							
	Not used	Not used	MP CHK counter parity error	Parity error in MMC internal bus	MP reset counter parity error	Hard timer parity error	Wait timer parity error	Hold timer parity error
17	MMC::MICCHK1STS							
	Not used	Wait time- out	XR decoder error (2A)	Not used	Not used	XR address parity error	Local bus data parity error	XR data parity error
18	Module ID							
19	Routine ID							
20	Failed Processor No.				Message code (x'0')			
21	SSID (low order)							
22	Symptom code (x'FF8E' : LDEV type = DKU871/x'EF8E' : LDEV type = DKU861)							
23								

Format 8, Message E (processor failure: DKA CHK1B)

	0	1	2	3	4	5	6	7
7	Format (x'8')				Message (x'E')			
8	Subcode x'63': QDTA CHK1B							
9	MMC::CHK1BSTS							
	Not used	Not used	Not used	Not used	Not used	CHA CHK1B	MPA CHK1B	MMC CHK1B
10	MMC::CHK1BSTS							
	FCA CHK1B	DTA CHK1B	Not used	Not used	Not used	Not used	RMC CHK1B	DRAM CHK1B
11	Not used							
12	QDTA::ESTA9							
	Write to unused register	Write to read-only register	Set A at CMD-A execute	Set B at CMD-B execute	Set C at 64CMD execute	Address2 parity error	Address3 parity error	Byte access error
13	QDTA::ESTA9							
	Input DT1 parity error	Input DT2 parity error	Address DEC parity error	Output DT0 parity error	Output DT1 parity error	DRR4 clock phase error	CHSN4 clock phase error	CHSN6 clock phase error
14	QDTA::ESTAA							
	DRB M-ACS error	P0 BUF M-ACS error	P1 BUF M-ACS error	CHSN XR SEQ error	EXEXA TRANSFE R	ERR AT EXECA	ERR AT EXECB	ERR AT EXECC
15	MMC::MICCHK1STS							
	Not used	Not used	Not used	Not used	Not used	Not used	XR decoder error (3B0)	XR decoder error (3B1)
16	MMC::MICCHK1STS							
	Not used	Not used	MP CHK counter parity error	Parity error in MMC internal bus	MP reset counter parity error	Hard timer parity error	Wait timer parity error	Hold timer parity error
17	MMC::MICCHK1STS							
	Not used	Wait time- out	XR decoder error (2A)	Not used	Not used	XR address parity error	Local bus data parity error	XR data parity error
18	Module ID							
19	Routine ID							
20	Failed Processor No.				Message code (x'0')			
21	SSID (low order)							
22	Symptom code (x'FF8E' : LDEV type = DKU87I/x'EF8E' : LDEV type = DKU86I)							
23								

Format 8, Message E (processor failure: DKA CHK1B)

	0	1	2	3	4	5	6	7
7	Format (x'8')				Message (x'E')			
8	Subcode x'64': MMC CHK1B							
9	MMC::CHK1BSTS							
	Not used	Not used	Not used	Not used	Not used	CHA CHK1B	MPA CHK1B	MMC CHK1B
10	MMC::CHK1BSTS							
	FCA CHK1B	DTA CHK1B	Not used	Not used	Not used	Not used	RMC CHK1B	DRAM CHK1B
11	MMC::MICCHK1STS							
	Not used	Not used	Not used	Not used	Not used	Not used	XR decoder error (3B0)	XR decoder error (3B1)
12	MMC::MICCHK1STS							
	Not used	Not used	MP CHK counter parity error	Parity error in MMC internal bus	MP reset counter parity error	Hard timer parity error	Wait timer parity error	Hold timer parity error
13	MMC::MICCHK1STS							
	Not used	Wait time- out	XR decoder error (2A)	Not used	Not used	XR address parity error	Local bus data parity error	XR data parity error
14	MMC::MPCERRSTS							
	Not used	Not used	WCHK1 at MPCHK	CHK1A at MPCHK	Timeout monitor timer parity error	A/B REG inconsistent check error	A/B REG write time- out	A/B REG access sequence error
15	MMC::MMCPERR							
	Not used	Not used	Not used	Not used	Data parity err in MMC <00-07>	Data parity err in MMC <10-17>	Data parity err in MMC <20-27>	Data parity err in MMC <30-37>
16	MMC::TIMERR							
	Timer 0 parity error	Timer 1 parity error	Timer 2 parity error	Timer 3 parity error	Timer 4 parity error	Timer 5 parity error	Timer 6 parity error	Timer 7 parity error
17	MMC::LBUSPER							
	Not used	Not used	Not used	Not used	L bus data parity error <00-07>	L bus data parity error <10-17>	L bus data parity error <20-27>	L bus data parity error <30-37>
18	Module ID							
19	Routine ID							
20	Failed Processor No.				Message code (x'0')			
21	SSID (low order)							
22	Symptom code (x'FF8E' : LDEV type = DKU87I/x'EF8E' : LDEV type = DKU86I)							
23								

Format 8, Message E (processor failure: DKA CHK1B)

	0	1	2	3	4	5	6	7
7	Format (x'8')				Message (x'E')			
8	Subcode x'65': MMC DRAM CHK1B							
9	MMC::CHK1BSTS							
	Not used	Not used	Not used	Not used	Not used	CHA CHK1B	MPA CHK1B	MMC CHK1B
10	MMC::CHK1BSTS							
	FCA CHK1B	DTA CHK1B	Not used	Not used	Not used	Not used	RMC CHK1B	DRAM CHK1B
11	MMC::DRAMC1BSTS							
	MPU correctable error	MMC FETCH correctable error	MPU XR read incorrect	MPU XR write incorrect	Not used	Not used	Not used	Not used
12	MMC::DRAMC1BSTS							
	Other correctable error	Not used	Other uncorrectabl e error	Not used	Not used	Not used	Not used	Not used
13	MMC::DRAMC1BSTS							
	Not used	Refresh request timer error	Not used	Refresh time out	Not used	Not used	Not used	Not used
14	MMC::ERADR							
	Error address in LM							
15	MMC::ERADR							
	Error address in LM							
16	MMC::ERADR							
	Error address in LM							
17	MMC::ERADR							
	Error address in LM						Not used	Not used
18	Module ID							
19	Routine ID							
20	Failed Processor No.				Message code (x'0')			
21	SSID (low order)							
22	Symptom code (x'FF8E' : LDEV type = DKU871/x'EF8E' : LDEV type = DKU861)							
23								

Format 8, Message E (processor failure: DKA CHK1B)

	0	1	2	3	4	5	6	7
7	Format (x'8')				Message (x'E')			
8	Subcode x'66': MMC FETCH CHK1B							
9	MMC::CHK1BSTS							
	Not used	Not used	Not used	Not used	Not used	CHA CHK1B	MPA CHK1B	MMC CHK1B
10	MMC::CHK1BSTS							
	FCA CHK1B	DTA CHK1B	Not used	Not used	Not used	Not used	RMC CHK1B	DRAM CHK1B
11	MMC::DRAMC1BSTS							
	MPU correctable error	MMC FETCH correctable error	MPU XR read incorrect	MPU XR write incorrect	Not used	Not used	Not used	Not used
12	MMC::DRAMC1BSTS							
	Other correctable error	Not used	Other uncorrectabl e error	Not used	Not used	Not used	Not used	Not used
13	MMC::DRAMC1BSTS							
	Not used	Refresh request timer error	Not used	Refresh time out	Not used	Not used	Not used	Not used
14	MMC::FERADR							
	Error address in fetch to LM							
15	MMC::FERADR							
	Error address in fetch to LM							
16	MMC::FERADR							
	Error address in fetch to LM							
17	MMC::FERADR							
	Error address in fetch to LM						Not used	Not used
18	Module ID							
19	Routine ID							
20	Failed Processor No.				Message code (x'0')			
21	SSID (low order)							
22	Symptom code (x'FF8E' : LDEV type = DKU871/x'EF8E' : LDEV type = DKU861)							
23								

Format 8, Message E (processor failure: DKA CHK1B)

	0	1	2	3	4	5	6	7
7	Format (x'8')				Message (x'E')			
8	Subcode x'67':RMC CHK1B							
9	MMC::CHK1BSTS							
	Not used	Not used	Not used	Not used	Not used	CHA CHK1B	MPA CHK1B	MMC CHK1B
10	MMC::CHK1BSTS							
	FCA CHK1B	DTA CHK1B	Not used	Not used	Not used	Not used	RMC CHK1B	DRAM CHK1B
11	Not used							
12	MMC::ERADR							
	Error address in LM							
13	MMC::ERADR							
	Error address in LM							
14	MMC::ERADR							
	Error address in LM							
15	MMC::ERADR							
	Error address in LM						Not used	Not used
16	RMC::RMCC1ASTS							
	RMC INT0	RMC INT1	RMC INT2	RMC INT3	RMC INT4	RMC INT5	RMC INT6	RMC INT7
17	RMC::RMCC1BSTS							
	RMC INT0	RMC INT1	RMC INT2	RMC INT3	RMC INT4	RMC INT5	RMC INT6	RMC INT7
18	Module ID							
19	Routine ID							
20	Failed Processor No.				Message code (x'0')			
21	SSID (low order)							
22	Symptom code (x'FF8E' : LDEV type = DKU87I/x'EF8E' : LDEV type = DKU86I)							
23								

Format 8, Message E (processor failure: DKA CHK1B)

	0	1	2	3	4	5	6	7
7	Format (x'8')				Message (x'E')			
8	Subcode x'70': MPA CHK1B							
9	MMC::CHK1BSTS							
	Not used	Not used	Not used	Not used	Not used	CHA CHK1B	MPA CHK1B	MMC CHK1B
10	MMC::CHK1BSTS							
	FCA CHK1B	DTA CHK1B	Not used	Not used	Not used	Not used	RMC CHK1B	DRAM CHK1B
11	MPA::MPASTS							
	MPAINT status bit	Master CHK3 occurred	Slave CHK3 occurred	Not used	PROM_IF CHK1B occurred	COM_IF CHK1B occurred	XR_IF CHK1B occurred	MPINT status bit
12	MPA::XWER							
	Access to not use address	Access to not use address	Access to not use address	Not used	Not used	Not used	Not used	XR byte access error
13	MPA::XWER							
	XR write address parity error				XR write data parity error			
	byte0	byte1	byte2	byte3	byte0	byte1	byte2	byte3
14	MPA::XRER							
	Not used	Not used	Not used	Not used	XR read data parity error			
					byte0	byte1	byte2	byte3
15	MMC::MICCHK1STS							
	Not used	Not used	Not used	Not used	Not used	Not used	XR decoder error (3B0)	XR decoder error (3B1)
16	MMC::MICCHK1STS							
	Not used	Not used	MP CHK counter parity error	Parity error in MMC internal bus	MP reset counter parity error	Hard timer parity error	Wait timer parity error	Hold timer parity error
17	MMC::MICCHK1STS							
	Not used	Wait time- out	XR decoder error (2A)	Not used	Not used	XR address parity error	Local bus data parity error	XR data parity error
18	Module ID							
19	Routine ID							
20	Failed Processor No.				Message code (x'0')			
21	SSID (low order)							
22	Symptom code (x'FF8E' : LDEV type = DKU87I/x'EF8E' : LDEV type = DKU86I)							
23								

Format 8, Message E (processor failure: DKA CHK1B)

	0	1	2	3	4	5	6	7
7	Format (x'8')				Message (x'E')			
8	Subcode x'71': FM CHK1B							
9	MMC::CHK1BSTS							
	Not used	Not used	Not used	Not used	Not used	CHA CHK1B	MPA CHK1B	MMC CHK1B
10	MMC::CHK1BSTS							
	FCA CHK1B	DTA CHK1B	Not used	Not used	Not used	Not used	RMC CHK1B	DRAM CHK1B
11	MPA::MPASTS							
	MPAINT status bit	Master CHK3 occurred	Slave CHK3 occurred	Not used	PROM_IF CHK1B occurred	COM_IF CHK1B occurred	XR_IF CHK1B occurred	MPINT status bit
12	MPA::XWER							
	Access to not use address	Access to not use address	Access to not use address	Not used	Not used	Not used	Not used	XR byte access error
13	MPA::XWER							
	XR write address parity error				XR write data parity error			
	byte0	byte1	byte2	byte3	byte0	byte1	byte2	byte3
14	MPA::XRER							
	Not used	Not used	Not used	Not used	XR read data parity error			
					byte0	byte1	byte2	byte3
15	MMC::MICCHK1STS							
	Not used	Not used	Not used	Not used	Not used	Not used	XR decoder error (3B0)	XR decoder error (3B1)
16	MMC::MICCHK1STS							
	Not used	Not used	MP CHK counter parity error	Parity error in MMC internal bus	MP reset counter parity error	Hard timer parity error	Wait timer parity error	Hold timer parity error
17	MMC::MICCHK1STS							
	Not used	Wait time- out	XR decoder error (2A)	Not used	Not used	XR address parity error	Local bus data parity error	XR data parity error
18	Module ID							
19	Routine ID							
20	Failed Processor No.				Message code (x'0')			
21	SSID (low order)							
22	Symptom code (x'FF8E' : LDEV type = DKU87I/x'EF8E' : LDEV type = DKU86I)							
23								

Format 8, Message E (processor failure: DKA CHK1B)

	0	1	2	3	4	5	6	7
7	Format (x'8')				Message (x'E')			
8	Subcode x'72': FCA CHK1B							
9	MMC::CHK1BSTS							
	Not used	Not used	Not used	Not used	Not used	CHA CHK1B	MPA CHK1B	MMC CHK1B
10	MMC::CHK1BSTS							
	FCA CHK1B	DTA CHK1B	Not used	Not used	Not used	Not used	RMC CHK1B	DRAM CHK1B
11	FCA::FCHK10							
	XR read data parity error				33MHz clock error	25MHz clock error	SEQ10 error	SEQ19 error
	Byte0	Byte1	Byte2	Byte3				
12	FCA::FCHK10							
	TLM read data parity error	PCI S error	Not used	Diagnose CHK1 occurred	PCI Devsel timeout	PCI TLM read address counter parity error	PCI target abort	PCI target ready
13	FCA::FCHK10							
	XR address parity error				XR write data parity error			
	Byte0	Byte1	Byte2	Byte3	Byte0	Byte1	Byte2	Byte3
14	FCA::FCHK10							
	TLM address counter parity error	ELM write address counter parity error	Not used	Not used	Not used	Not used	Not used	Not used
15	MMC::MICCHK1STS							
	Not used	Not used	Not used	Not used	Not used	Not used	XR decoder error (3B0)	XR decoder error (3B1)
16	MMC::MICCHK1STS							
	Not used	Not used	MP CHK counter parity error	Parity error in MMC internal bus	MP reset counter parity error	Hard timer parity error	Wait timer parity error	Hold timer parity error
17	MMC::MICCHK1STS							
	Not used	Wait time- out	XR decoder error (2A)	Not used	Not used	XR address parity error	Local bus data parity error	XR data parity error
18	Module ID							
19	Routine ID							
20	Failed Processor No.				Message code (x'0')			
21	SSID (low order)							
22	Symptom code (x'FF8E' : LDEV type = DKU871/x'EF8E' : LDEV type = DKU861)							
23								

Format 8, Message E (processor failure: DKA CHK1B)

	0	1	2	3	4	5	6	7
7	Format (x'8')				Message (x'E')			
8	Subcode x'73': QDTA CHK1B							
9	MMC::CHK1BSTS							
	Not used	Not used	Not used	Not used	Not used	CHA CHK1B	MPA CHK1B	MMC CHK1B
10	MMC::CHK1BSTS							
	FCA CHK1B	DTA CHK1B	Not used	Not used	Not used	Not used	RMC CHK1B	DRAM CHK1B
11	Not used							
12	QDTA::ESTA9							
	Write to unused register	Write to read-only register	Set A at CMD-A execute	Set B at CMD-B execute	Set C at 64CMD execute	Address2 parity error	Address3 parity error	Byte access error
13	QDTA::ESTA9							
	Input DT1 parity error	Input DT2 parity error	Address DEC parity error	Output DT0 parity error	Output DT1 parity error	DRR4 clock phase error	CHSN4 clock phase error	CHSN6 clock phase error
14	QDTA::ESTAA							
	DRB M-ACS error	P0 BUF M-ACS error	P1 BUF M-ACS error	CHSN XR SEQ error	EXEXA TRANSFE R	ERR AT EXECA	ERR AT EXECB	ERR AT EXECC
15	MMC::MICCHK1STS							
	Not used	Not used	Not used	Not used	Not used	Not used	XR decoder error (3B0)	XR decoder error (3B1)
16	MMC::MICCHK1STS							
	Not used	Not used	MP CHK counter parity error	Parity error in MMC internal bus	MP reset counter parity error	Hard timer parity error	Wait timer parity error	Hold timer parity error
17	MMC::MICCHK1STS							
	Not used	Wait time- out	XR decoder error (2A)	Not used	Not used	XR address parity error	Local bus data parity error	XR data parity error
18	Module ID							
19	Routine ID							
20	Failed Processor No.				Message code (x'0')			
21	SSID (low order)							
22	Symptom code (x'FF8E' : LDEV type = DKU87I/x'EF8E' : LDEV type = DKU86I)							
23								

Format 8, Message E (processor failure: DKA CHK1B)

	0	1	2	3	4	5	6	7
7	Format (x'8')				Message (x'E')			
8	Subcode x'74': MMC CHK1B							
9	MMC::CHK1BSTS							
	Not used	Not used	Not used	Not used	Not used	CHA CHK1B	MPA CHK1B	MMC CHK1B
10	MMC::CHK1BSTS							
	FCA CHK1B	DTA CHK1B	Not used	Not used	Not used	Not used	RMC CHK1B	DRAM CHK1B
11	MMC::MICCHK1STS							
	Not used	Not used	Not used	Not used	Not used	Not used	XR decoder error (3B0)	XR decoder error (3B1)
12	MMC::MICCHK1STS							
	Not used	Not used	MP CHK counter parity error	Parity error in MMC internal bus	MP reset counter parity error	Hard timer parity error	Wait timer parity error	Hold timer parity error
13	MMC::MICCHK1STS							
	Not used	Wait time- out	XR decoder error (2A)	Not used	Not used	XR address parity error	Local bus data parity error	XR data parity error
14	MMC::MPCERRSTS							
	Not used	Not used	WCHK1 at MPCHK	CHK1A at MPCHK	Timeout monitor timer parity error	A/B REG inconsistent check error	A/B REG write time- out	A/B REG access sequence error
15	MMC::MMCPERR							
	Not used	Not used	Not used	Not used	Data parity err in MMC <00-07>	Data parity err in MMC <10-17>	Data parity err in MMC <20-27>	Data parity err in MMC <30-37>
16	MMC::TIMERR							
	Timer 0 parity error	Timer 1 parity error	Timer 2 parity error	Timer 3 parity error	Timer 4 parity error	Timer 5 parity error	Timer 6 parity error	Timer7 parity error
17	MMC::LBUSPER							
	Not used	Not used	Not used	Not used	L bus data parity error <00-07>	L bus data parity error <10-17>	L bus data parity error <20-27>	L bus data parity error <30-37>
18	Module ID							
19	Routine ID							
20	Failed Processor No.				Message code (x'0')			
21	SSID (low order)							
22	Symptom code (x'FF8E' : LDEV type = DKU87I/x'EF8E' : LDEV type = DKU86I)							
23								

Format 8, Message E (processor failure: DKA CHK1B)

	0	1	2	3	4	5	6	7
7	Format (x'8')				Message (x'E')			
8	Subcode x'75': MMC DRAM CHK1B							
9	MMC::CHK1BSTS							
	Not used	Not used	Not used	Not used	Not used	CHA CHK1B	MPA CHK1B	MMC CHK1B
10	MMC::CHK1BSTS							
	FCA CHK1B	DTA CHK1B	Not used	Not used	Not used	Not used	RMC CHK1B	DRAM CHK1B
11	MMC::DRAMC1BSTS							
	MPU correctable error	MMC FETCH correctable error	MPU XR read incorrect	MPU XR write incorrect	Not used	Not used	Not used	Not used
12	MMC::DRAMC1BSTS							
	Other correctable error	Not used	Other uncorrectabl e error	Not used	Not used	Not used	Not used	Not used
13	MMC::DRAMC1BSTS							
	Not used	Refresh request timer error	Not used	Refresh time out	Not used	Not used	Not used	Not used
14	MMC::ERADR							
	Error address in LM							
15	MMC::ERADR							
	Error address in LM							
16	MMC::ERADR							
	Error address in LM							
17	MMC::ERADR							
	Error address in LM						Not used	Not used
18	Module ID							
19	Routine ID							
20	Failed Processor No.				Message code (x'0')			
21	SSID (low order)							
22	Symptom code (x'FF8E' : LDEV type = DKU871/x'EF8E' : LDEV type = DKU861)							
23								

Format 8, Message E (processor failure: Micro WCHK1)

	0	1	2	3	4	5	6	7
7	Format (x'8')				Message (x'E')			
8	Subcode (x'F0': Micro WCHK1)							
9	Micro information							
10	Micro information							
11	Micro information							
12	Micro information							
13	Micro information							
14	Micro information							
15	Micro information							
16	Micro information							
17	Micro information							
18	Module ID							
19	Routine ID							
20	Failed Processor No.				Message code (x'0')			
21	SSID of self subsystem (low order)							
22	Symptom code (x'FF8E':LDEV type=DKU87I / x'EF8E':LDEV type=DKU86I)							
23								

Format 8, Message E (processor failure: CHK1A)

	0	1	2	3	4	5	6	7
7	Format (x'8')				Message (x'E')			
8	Subcode x'F1': CHK1A caused by Micro							
9	RMC::ERADR							
	Address from L bus							
10	RMC::ERADR							
	Address from L bus							
11	RMC::ERADR							
	Address from L bus							
12	RMC::ERADR							
	Address from L bus						Not used	Not used
13	RMC::LMADRLMT							
	Not used	Not used	Not used	Not used	Not used	Not used	Upper limit address of LM mounting area	
14	RMC::LMADRLMT							
	Upper limit address of LM mounting area							
15	RMC::ERWR							
	Not used	Not used	Not used	Not used	Not used	Not used	Not used	WR signal value
16	RMC::ERSTS0							
	Not used	Not used	Not used	CHK1A cause detected	CHK1B cause detected	LM, XR Access error in scanning	DRAM control signal error	Not used
17	RMC::CHK1ASTS							
	MPU UNCER	MMC FETCH UNCER	MPU WR PROT	MPU ADR OVER	Not used	Not used	OTHER WR PROT	OTHER ADR OVER
18	Module ID							
19	Routine ID							
20	Failed Processor No.				Message code (x'0')			
21	SSID (low order)							
22	Symptom code (x'FF8E' : LDEV type = DKU87I/x'EF8E' : LDEV type = DKU86I)							
23								

Format 8, Message E (processor failure: CHK1A)

	0	1	2	3	4	5	6	7
7	Format (x'8')				Message (x'E')			
8	Subcode x'FE': CHK1A undefined hardware reason							
9	MMC::C1WSTS							
	Not used	Not used	Not used	Not used	Not used	Not used	Not used	Not used
10	MMC::C1WSTS							
	CHK1A occurred	WCHK1 occurred	CHK1A occurred in MPCHK	CHK1A occurred at RMC	CHK1A occurred at DRAM	WCHK1 occurred in MPCHK	WCHK1 by CHK1A in CHK1A	Micro-force WCHK1
11	Not used							
12	Not used							
13	Not used							
14	Not used							
15	Not used							
16	Not used							
17	Not used							
18	Module ID							
19	Routine ID							
20	Failed Processor No.				Message code (x'0')			
21	SSID (low order)							
22	Symptom code (x'FF8E' : LDEV type = DKU87I/x'EF8E' : LDEV type = DKU86I)							
23								

Format 8, Message E (processor failure: CHK1B)

	0	1	2	3	4	5	6	7
7	Format (x'8')				Message (x'E')			
8	Subcode x'FF': CHK1B undefined hardware reason							
9	MMC::CHK1BSTS							
	Not used	Not used	Not used	Not used	Not used	CHA CHK1B	MPA CHK1B	MMC CHK1B
10	MMC::CHK1BSTS							
	FCA CHK1B	DTA CHK1B	Not used	Not used	Not used	Not used	RMC CHK1B	DRAM CHK1B
11	Not used							
12	Not used							
13	Not used							
14	Not used							
15	Not used							
16	Not used							
17	Not used							
18	Module ID							
19	Routine ID							
20	Failed Processor No.				Message code (x'0')			
21	SSID (low order)							
22	Symptom code (x'FF8E' : LDEV type = DKU87I/x'EF8E' : LDEV type = DKU86I)							
23								

Format 8, Message E (Selective Reset)

	0	1	2	3	4	5	6	7
7	Format (x'8')				Message (x'E')			
8	Not used (x'00')							
9	DCN status							
	Force device busy	Channel connect request	Command chain execute	Path reserve	Stack status	Sense pending	Long Busy (Command process)	Processor connect
10	DCN status							
	Single path mode	Garant path mode	(RSV)	(RSV)	(RSV)	(RSV)	(RSV)	Garant path MP
11	DCN flag							
	RST NTF/RST ALG SSB PND	Pin Data pending	(RSV)	(RSV)	ODE pending	RSQ pending	SCI/SCE pending	PCH pending
12	LCT initiation cause							
	0: Ready 1: Not ready	0: Disable 1: Enable	0: No SNS 1: 64 SNS pending	0: Mount 1: Not mount	0: No RST ALG LPN 1: Exist	0: No SYS RST LPN 1: Exist	0: No stack 1: Exist	0: No Wait SNS 1: Exist
13	LCT initiation cause							
	0: No Wait-RI 1: Exist	(RSV)	(RSV)	(RSV)	(RSV)	(RSV)	(RSV)	0: Others 1: DEV BSY JOB
14	Command interface flag							
	Pending exist	SCE(RSP)	(RSV)	(RSV)	ODE pending	RSG pending	SCI pending	PCH pending
15	Command code							
16	Internal SSB log No.							
17								
18	Detail log number for RESET							
19								
20	PCB number				Message code (x'1') (Note)			
21	SSID (lower order) of self subsystem							
22	Symptom code (x'FF8E':LDEV type=DKU87I / x'EF8E':LDEV type=DKU86I)							
23								

(Note) Indicates the 'Selective Reset'.

Format 8, Message E (Wait SENSE Timeout)

	0	1	2	3	4	5	6	7
7	Format (x'8')				Message (x'E')			
8	Not used (x'00')							
9	LDEV#							
10*	Basic sense byte 0							
	Basic sense byte 0							
11*	Basic sense byte 1							
	Basic sense byte 1							
12*	Basic sense byte 2							
	Exception code (higher order)							
13*	Format/Message							
	Exception code (lower order)							
14*	Module ID							
	Module ID							
15*	Routine ID							
	Routine ID							
16	Internal SSB number for RESET							
17								
18								
18	Detail log number for RESET							
19								
19								
20	PCB number				Message code (x'3') (Note)			
21	SSID (lower order) of self subsystem							
22	Symptom code (x'FF8E':LDEV type=DKU87I / x'EF8E':LDEV type=DKU86I)							
23								

* Timeout SSB information

Upper case: 24-byte format SSB

Lower case: 32-byte format SSB

(Note) Indicates the 'Wait SENSE Timeout'.

Format 8, Message E (CHK1B Reset)

	0	1	2	3	4	5	6	7
7	Format (x'8')				Message (x'E')			
8	Related failure internal SSB log No. (Error procedure aid)							
9								
10								
11	Not used (x'00')							
12	OLD PSW (interruption source address)							
13								
14								
15								
16	Internal SSB log No. (reset)							
17	Detail log number for RESET							
18								
19								
20	PCB number				Message code (x'5') (Note)			
21	SSID (lower order) of self subsystem							
22	Symptom code (x'FF8E':LDEV type=DKU87I / x'EF8E':LDEV type=DKU86I)							
23								

(Note) Indicates the 'CHK1B Reset'.

Format 8, Message E (DKC Internal Reset)

	0	1	2	3	4	5	6	7
7	Format (x'8')				Message (x'E')			
8	Not used (x'00')							
9								
10								
11								
12	OLD PSW (interruption source address)							
13								
14								
15								
16	Internal SSB log No.							
17								
18	Detail log number for RESET							
19								
20	PCB number				Message code (x'6') (Note)			
21	SSID (lower order) of self subsystem							
22	Symptom code (x'FF8E':LDEV type=DKU87I / x'EF8E':LDEV type=DKU86I)							
23								

(Note) Indicates the 'DKC Internal Reset'.

Format 8, Message E (LCP Internal Reset)

	0	1	2	3	4	5	6	7
7	Format (x'8')				Message (x'E')			
8	Not used (x'00')							
9	Not used (x'00')							
10	Reset cause							
11								
12*	OLD PSW (0)							
	LCP error code (higher order)							
13*	OLD PSW (1)							
	LCP error code (lower order)							
14*	OLD PSW (2)							
	x'00'							
15*	OLD PSW (3)							
	x'00'							
16	Internal SSB No.							
17								
18	Detail log number for RESET							
19								
20	PCB number				Message code (x'7') (Note)			
21	SSID (lower order) of self subsystem							
22	Symptom code (x'FF8E':LDEV type=DKU87I / x'EF8E':LDEV type=DKU86I)							
23								

- * Upper case: Hot line
 Lower case: Int Sel Reset

(Note) Indicates the 'LCP Internal Reset'.

Format 8, Message E (Force Reset)

	0	1	2	3	4	5	6	7
7	Format (x'8')				Message (x'E')			
8	Not used (x'00')							
9								
10								
11								
12	OLD PSW (interruption source address)							
13								
14								
15								
16	Internal SSB log No.							
17								
18	Detail log number for RESET							
19								
20	PCB number				Message code (x'8') (Note)			
21	SSID (lower order) of self subsystem							
22	Symptom code (x'FF8E':LDEV type=DKU87I / x'EF8E':LDEV type=DKU86I)							
23								

(Note) Indicates the 'Force Reset'.

Format 8, Message E (Logical inconsistency reset)

	0	1	2	3	4	5	6	7
7	Format (x'8')				Message (x'E')			
8	Not used							
9								
10								
11								
12	OLD PSW (interruption source address)							
13								
14								
15								
16	Internal SSB log number							
17								
18	Detail log number for RESET							
19								
20	PCB number				Message code (x'9') (Note)			
21	SSID (lower order) of self subsystem							
22	Symptom code (x'FF8E':LDEV type=DKU87I / x'EF8E':LDEV type=DKU86I)							
23								

(Note) Indicates the 'Logical inconsistency reset'.

Format 8, Message F (Micro-program detected error : Logical inconsistency)

	0	1	2	3	4	5	6	7
7	Format (x'8')				Message (x'F')			
8	Module ID							
9	Routine ID							
10	Error information							
11								
12								
13								
14								
15								
16								
17								
18								
19								
20	PCB number				Message code (don't care)			
21	SSID (lower order) of self subsystem							
22	Symptom code (high order) (x'FF':LDEV type=DKU87I / x'EF':LDEV type=DKU86I)							
23	Symptom code (low order) (x'8F')							

Module ID (SSB8) List (1/4)

No.	Module ID	Function name	Remarks
1	00	Initialization	
2	01	Power disconnection	
3	02	CUDG	
4	10	Job management	
5	11	Synchronous management	
6	12	Communication control between processors	
7	13	Cache control	
8	14	Resource management	
9	15	Configuration control	
10	16	Reset	
11	17	SVP management	
12	18	Configuration control (RAID provided)	
13	19	Configuration control (drive recovery provided)	
14	30	Standard function	
15	31	SVP-provided function	
16	32	Error procedure aid	
17	40	CHA monitor	
18	41	CHA initiator	
19	42	CHA terminator	
20	43	CHA kernel (common function)	
21	48	Remote copy command	
22	49	Remote copy command	
23	50	Command chain start	
24	51	Command chain termination	
25	52	Command execution status analysis	
26	53	Command execution CHL I/F control	
27	54	Channel server common process 1	
28	55	Channel server common process 2	
29	56	Channel server common process 3	
30	57	Channel server common process 4	
31	58	Channel server data transfer 1	
32	59	Channel server data transfer 2	
33	5A	Read/write common process	

Module ID (SSB8) List (2/4)

No.	Module ID	Function name	Remarks
34	5B	Subsystem command common process	
35	5C	Channel server asynchronous control 1	
36	5D	Channel server asynchronous control 2	
37	5E	Channel server command queuing control	
38	5F	Channel server JOB FRR	
39	60	Read command process 1	
40	61	Read command process 2	
41	62	Read command process 3	
42	63	Read command process 4	
43	64	Read command process 5	
44	65	Read command process 6	
45	66	Write command process 1	
46	67	Write command process 2	
47	68	Write command process 3	
48	69	Write command process 4	
49	6A	Write command process 5	
50	6B	Write command process 6	
51	6D	Control command process 1	
52	6E	Control command process 2	
53	6F	Search command	
54	70	Path control command process	
55	71	Diagnostic command process	
56	72	DIAG command process	
57	73	Subsystem command process 1	
58	74	Subsystem command process 2	
59	75	Subsystem command process 3	
60	78	CHL I/F link level frame control	
61	79	CHL I/F device frame control	
62	7A	CHL I/F common control	
63	7B	LDEV format	
64	7E	Concurrent copy process	

Module ID (SSB8) List (3/4)

No.	Module ID	Function name	Remarks
65	7F	Channel server WDCP/differential (M specified)	
66	80	DKA monitor	
67	81	DKA initiator	
68	82	DKA terminator	
69	90	Staging	
70	91	LDEV destaging	
71	92	PDEV destaging	
72	93	Drive recovery	
73	94	Offline monitor	
74	95	Physical drive maintenance	
75	98	RAID synchronous type	
76	99	RAID LDEV destaging	
77	9A	RAID PDEV destaging	
78	9B	RAID drive recovery	
79	9C	RAID external provided	
80	9D	RAID 0 destaging	
81	9E	RAID 0 Error/merge	
82	9F	RAID failed slot operation	
83	A0	SCSI control	
84	A1	DRR control	
85	A2	SVP command execution	
86	A3	Test activation	
87	A4	SCSI control	
88	A5	Offline monitor	
89	A6	Physical drive maintenance	
90	A7	SCSI control	
91	A8	DRR control	
92	AE	SCSI control	
93	C0	HRC/HODM CHL/SVP I/F	
94	C1	HRC/HODM Remote copy monitor	
95	C2	HRC/HODM Configuration control	

Module ID (SSB8) List (4/4)

No.	Module ID	Function name	Remarks
96	C3	HRC/HODM common copy procedure	
97	C4	HRC Remote copy procedure	
98	C5	HODM Migration copy procedure	
99	C6	HRC/HODM channel server procedure	Note 1
100	C7	HRC/HODM Remote I/O manager	
101	C8	HRC/HODM Remote I/O 1	Note 1
102	C9	HRC/HODM Remote I/O 2	
103	CA	HRC/HODM path control	
104	CB	HRC asynchronous remote copy procedure	
105	CC	HRC asynchronous CT manager	
106	CD	HRC asynchronous scheduler	
107	CE	HRC Configuration control	
108	CF	HRC/HODM Configuration control	

(Note 1) No action is required for error codes, C60E, C870, C871 and C872. These error codes are reported only to have the host processor re-drive the failed CCW chain.

Format F, Message 0 (Operation terminated)

	0	1	2	3	4	5	6	7
7	Format (x'F')				Message (x'0')			
8	Not used (x'00000')							
9								
10								
11	Hardware level (Note)							
12								
13	SSID of mate subsystem (x'0000' for EDCC)							
14								
15	Manufacturer code ('00000')					Factory code ('00')		
16	Not used (x'00')							
17	Module ID							
18	Routine ID							
19	Processor number				Error code (don't care)			
20	SSID of self subsystem							
21								
22								
23	Symptom code (x'FFF0')							

(Note) Hardware level

Bit 0 : Hardware level

When the bit 0 = 0,

Bit 1: Not used
 Bit 2-3: Reported storage path
 Bit 4-5: Number of channels per cluster
 00 : 4
 01 : 8
 10 : Not used
 11 : Not used
 Bit 6: NVS
 0 : Not exist
 1 : Exist
 Bit 7: Not used
 Bit 8-10: Cache size
 000 : Non cache
 001 : 256MB
 010 : 512MB
 011 : 768MB
 100 : 1024MB
 101 : 1280MB
 110 : 1536MB
 111 : Over 1536MB
 Bit 11-13: Cluster hardware level
 Bit 14-15: Cache/ NVS hardware level

When the bit 0 = 1,

Bit 1: Not used
 Bit 2-3: Failed storage path
 Bit 4-7: Number of channels per cluster
 0000 : Parallel channel = 4, serial channel = 0
 0001 : Parallel channel = 8, serial channel = 0
 0010 : Parallel channel = 4, serial channel = 2
 0100 : Parallel channel = 4, serial channel = 4
 0110 : Parallel channel = 0, serial channel = 2
 1000 : Parallel channel = 0, serial channel = 4
 1010 : Parallel channel = 0, serial channel = 8
 1100 : Parallel channel = 4, serial channel = 6
 Bit 8: Dual frame
 0 : Dual frame
 1 : Modular power
 Bit 9-11: Cache size
 000 : Non cache
 001 : 256MB
 010 : 512MB
 011 : 768MB
 100 : 1024MB
 101 : 1280MB
 110 : 1536MB
 111 : Over 1536MB
 Bit 11-13: Cluster hardware level
 Bit 14-15: Cache/ NVS hardware level

Format F, Message 1 (Micro-program detected cache failure)

	0	1	2	3	4	5	6	7
7	Format (x'F')				Message (x'1')			
8	Queue transition in progress (Side A)	Queue transition in progress (Side B)	Free SGCB queue operation in progress	Free SLCB queue operation in progress	Free GRPT queue operation in progress	Not used		
9*	Not used							
	VDEV number							
10*	Queue type							
	VDEV number		Slot number					
11*	Queue number							
	Slot number							
12*	Queue number							
	Slot number							
13	SSID of mate subsystem							
14	(x'0000' for EDCC)							
15	Manufacture code ('000000')					Factory code ('00')		
16	Not used							
17	Module ID							
18	Routine ID							
19	Processor number				Error code (don't care)			
20	SSID of self subsystem							
21								
22	Symptom code (x'FFF1')							
23								

- * When byte 8, bit 2-4 = 000, upper value is valid.
When byte 8, bit 2-4 ≠ 000, lower value is valid.

Format F, Message 2 (Cache Failre)

	0	1	2	3	4	5	6	7
7	Format (x'F')				Message (x'2')			
8	SubCode							
	Error Detected: '1'= P PATH ERR(DTA), '2'= P or C PATH ERR(DTA) '3'= P PATH ERR(CSW) '4'= P or C PATH ERR(CSW) '5'= C PATH ERR(CSW), '7'= C PATH ERR(CMA) '8'= CACHE BOARD ERR, '9'= CACHE MEMORY ERR				CARB BOARD ERR '0'= NO '1'= YES	CMA BOARD ERR '0'= NO '1'= YES	CARB REG LOG RESULT '0'= OK '1'= NG	CMA REG LOG RESULT '0'= OK '1'= NG
9	Transfer Information							
	Transfer P/K Type and Master Path '0'= ESCON CHA, '1'=FICON CHA '3'= FIBRE CHA(PMA), '4'= FIBRE CHA(DMA0) '5'= FIBRE CHA(DMA1) '6'= FIBRE DKA(FCA0), '7'= FIBRE DKA(FCA1), '8'= FIBRE DKA(DRR) 'A'=ENAS CHA(DMA0/2), 'B'=ENAS CHA(DMA1/3)				Transfer Mode '0'= NORMAL WRITE '1'= NORMAL READ '2'= 2SLAVE WRITE '3'= CACHE COPY(CtoC) '4'= CACHE COPY(CinC)			
10	Using Path Code							
	XFR P PATH# '0'= P#0 '1'= P#1	SLAVE#1 CACHE P/K# ('0' - '3')	SLAVE#1 CMA# ('0' - '1')	LOG P PATH# '0'=ORIGIN '1'=OTHER	SLAVE#2 CACHE P/K# ('0' - '3')	SLAVE#2 CMA# ('0' - '1')		
11	STATUS0(SLAVE 1) byte0							
	STATUS0 ERR	STATUS0 CARB ERR	STATUS0 CMA ERR	STATUS0 CMA STATUS ID ERR	STATUS0 CMA STATUS NG	STATUS0 CMA FIFO MODE	STATUS0 CMA WARNING	STATUS0 CARB UNINITIAL
12	STATUS1(SLAVE 2) byte0							
	STATUS1 ERR	STATUS1 CARB ERR	STATUS1 CMA ERR	STATUS1 CMA STATUS ID ERR	STATUS1 CMA STATUS NG	STATUS1 CMA FIFO MODE	STATUS1 CMA WARNING	STATUS1 CARB UNINITIAL
13	SSID for Other Subsystem ('0000')							
14								
15	Maker Code ('000000')						Factory Code ('00')	
16	STATUS0(SLAVE 1) byte1							
	STATUS0 Reserved	STATUS0 PATH ID#			STATUS0 CMA UNINITIAL	STATUS0 Answer CACHE#		STATUS0 Answer CMA#
17	Module ID							
18	Routine ID							
19	P/K ID				ErrCode (Don't Care)			
20	SSID for Self Subsystem							
21								
22	Symptom Code (x'FFF2')							
23								

Format F, Message 5 (Remote Copy Paths Removed/Restored)

	0	1	2	3	4	5	6	7
7	Format (x'F')				Message (x'5')			
8	Reason code (Note)							
9	RCU device address							
10	RCU Manufacture code/Factory code							
11	(x'0400')							
12	RCU Sequence No.							
13								
14								
15	MCU Manufacture code/Factory code							
16	(x'0C24')							
17	MCU Sequence No.							
18								
19								
20	SSID of self subsystem							
21								
22	Symptom code							
23	(x'3887')							

(Note) Reason Code

x'01' : One or more remote copy paths removed unexpectedly

x'02' : One or more remote copy paths restored

x'03' : All remote copy paths removed unexpectedly

Format F, Message 6 (CFW impossible)

	0	1	2	3	4	5	6	7
7	Format (x'F')				Message (x'6')			
8	Reason code (Note)							
9	Not used							
10								
11								
12								
13	SSID of mate subsystem							
14	(x'0000' for EDCC)							
15	Manufacturer code ('000000')						Factory code ('00')	
16	Not used							
17	Module ID							
18	Routine ID							
19	Processor number				Error code (don't care)			
20	SSID of self subsystem							
21								
22	Symptom code (x'FFF6')							
23								

(Note) Reason code

x'00' : Reserved
 x'01' : CFW ID inconsistent
 x'02'-x'0F' : Reserved

Format F, Message A (NVS terminated)

	0	1	2	3	4	5	6	7
7	Format (x'F')				Message (x'A')			
8	Reason code (Note)							
9	Not used							
10								
11								
12								
13	SSID of mate subsystem							
14	(x'0000' for EDCC)							
15	Manufacturer code ('000000')						Factory code ('00')	
16	Not used							
17	Module ID							
18	Routine ID							
19	Processor number				Error code (don't care)			
20	SSID of self subsystem							
21								
22	Symptom code (x'FFFA')							
23								

(Note) Reason code
x'00'-x'01' : Reserved
x'02' : NVS failure
x'03'-x'0F' : Reserved

Format F, Message B (HRC/HODM Pair Suspend)

	0	1	2	3	4	5	6	7
7	Format (x'F')				Message (x'B')			
8	R-Vol suspended	R-Vol failed	Reason code (Note)					
9	RCU device address							
10	RCU Manufacture code/Factory code							
11	(x'0C220')							
12	RCU Sequence No.							
13	RCU Sequence No.							
14	RCU Sequence No.							
15	MCU Manufacture code/Factory code							
16	(x'0C225')							
17	MCU Sequence No.							
18	MCU Sequence No.							
19	MCU Sequence No.							
20	MCU Sequence No.							
21	MCU Sequence No.							
22	Symptom code (x'FE')							
23	Symptom code (same byte #8)							

(Note) Reason code

- x'14'-x'2F' : Reserved
- x'30' : Pair suspended. MCU device write error.
- x'31' : Pair suspended. RCU subsystem error/or MCU subsystem error.
- x'32' : Pair suspended. RCU device communication error.
- x'33' : Pair suspended (Critical device status). All write command is rejected until pair re-established.
- x'34' : Pair suspended. RCU device is not ready (intervention required).

Format F, Message F (Cache memory : Correctable error)

	0	1	2	3	4	5	6	7
7	Format (x'F')				Message (x'F')			
8	Subcode : x'02' : Cache 1 symbol error							
9	MPID (reported SSB)							
10	Not used (x'00')							
11	Not used (x'00')							
12	Not used (x'00')							
13	Not used (x'00')							
14	Not used (x'00')							
15	Not used (x'00')							
16	Not used (x'00')							
17	Module ID							
18	Routine ID							
19	PKID				Not used (x'0')			
20	SSID of self subsystem							
21								
22	Symptom code (x'FFFF')							
23								

Format F, Message F (Shared memory : Correctable error)

	0	1	2	3	4	5	6	7
7	Format (x'F')				Message (x'F')			
8	Subcode : x'04' : Shared memory 1 symbol error							
9	MPID (reported SSB)							
10	Not used (x'00')							
11	Not used (x'00')							
12	Slot number of shared memory (Side A : x'00', Side B : x'01')							
13	Not used (x'00')							
14	Not used (x'00')							
15	Not used (x'00')							
16	Not used (x'00')							
17	Module ID							
18	Routine ID							
19	PKID				Not used (x'0')			
20	SSID of self subsystem							
21								
22	Symptom code (x'FFFF')							
23								

Format F, Message F (Shared memory : Warning)

	0	1	2	3	4	5	6	7
7	Format (x'F')				Message (x'F')			
8	Subcode : x'08' : Three SM(A) DISABLE lines inconsistent x'09' : Three SM(B) DISABLE lines inconsistent							
9	MPID (reported SSB)							
10	Not used (x'00')							
11	Threshold counter for this warning							
12	MPA::HOUT							
	SMDA(0-2) Signal ALL	SMDA0 Signal	SMDA1 Signal	SMDA2 Signal	SMDB(0-2) signal ALL	SMDB0 Signal	SMDB1 Signal	SMDB2 Signal
13	Not used (x'00')							
14	Not used (x'00')							
15	Not used (x'00')							
16	MPA::HIN							
	SMDA(0-2) MV	SMDA0 Status	SMDA1 Status	SMDA2 Status	SMDB(0-2) MV	SMDB0 Status	SMDB1 Status	SMDB2 Status
17	Module ID							
18	Routine ID							
19	PKID				Not used (x'0')			
20	SSID of self subsystem							
21								
22	Symptom code (x'FFFF')							
23								

Format F, Message F (Scan : Warning)

	0	1	2	3	4	5	6	7
7	Format (x'F')				Message (x'F')			
8	Subcode : x'10' : SMA slave error							
9	MPID (reported SSB)							
10	Not used (x'00')							
11	Not used (x'00')							
12	Slot number of shared memory (Side A : x'00', Side B : x'01')							
13	Not used (x'00')							
14	Not used (x'00')							
15	Not used (x'00')							
16	PKID (scan slave)							
17	Module ID							
18	Routine ID							
19	PKID				Not used (x'0')			
20	SSID of self subsystem							
21								
22	Symptom code (x'FFFF')							
23								

Format F, Message F (Scan : Warning)

	0	1	2	3	4	5	6	7
7	Format (x'F')				Message (x'F')			
8	Subcode : x'11' : MPA slave error							
9	MPID (reported SSB)							
10	Not used (x'00')							
11	Not used (x'00')							
12	SMA (Side A : x'02', Side B : x'01')							
13	Not used (x'00')							
14	Not used (x'00')							
15	Not used (x'00')							
16	PKID (reported SSB)							
17	Module ID							
18	Routine ID							
19	PKID				Not used (x'0')			
20	SSID of self subsystem							
21								
22	Symptom code (x'FFFF')							
23								

Format F, Message F (Scan : Warning)

	0	1	2	3	4	5	6	7
7	Format (x'F')				Message (x'F')			
8	Subcode : x'12' : SMA SCINT error							
9	MPID (reported SSB)							
10	Not used (x'00')							
11	Not used (x'00')							
12	SMA (Side A : x'00', Side B : x'01')							
13	Not used (x'00')							
14	Not used (x'00')							
15	Not used (x'00')							
16	MPID (reported SSB)							
17	Module ID							
18	Routine ID							
19	PKID				Not used (x'0')			
20	SSID of self subsystem							
21								
22	Symptom code (x'FFFF')							
23								

Format F, Message F (Broadcast : Warning)

	0	1	2	3	4	5	6	7
7	Format (x'F')				Message (x'F')			
8	Subcode : x'13' : SMA BCINT error							
9	MPID (reported SSB)							
10	Not used (x'00')							
11	Not used (x'00')							
12	SMA (Side A : x'00', Side B : x'01')							
13	Not used (x'00')							
14	Not used (x'00')							
15	Not used (x'00')							
16	MPID (reported SSB)							
17	Module ID							
18	Routine ID							
19	PKID				Not used (x'0')			
20	SSID of self subsystem							
21								
22	Symptom code (x'FFFF')							
23								

Format F, Message F (LED BUS : Warning)

	0	1	2	3	4	5	6	7
7	Format (x'F')				Message (x'F')			
8	Subcode : x'20' : FSW LED BUS test error							
9	MPID (reported SSB)							
10	FCA::LEDADRDT							
	Address of LED BUS							
11	FCA::LEDADRDT							
	Data of LED BUS							
12	FCA::LEDCMD							
	Not used	Not used	Not used	Not used	Not used	Not used	READ CMD	WRITE CMD
13	Not used (x'00')							
14	Not used (x'00')							
15	Not used (x'00')							
16	FCA::LEDSTAT							
	Not used	Not used	Not used	Not used	Not used	Not used	Not used	Not used
17	Module ID							
18	Routine ID							
19	PKID				Not used (x'0')			
20	SSID of self subsystem							
21								
22	Symptom code (x'FFFF')							
23								

Format F, Message F (Abnormal MODE : Warning)

	0	1	2	3	4	5	6	7
7	Format (x'F')				Message (x'F')			
8	Subcode : x'40' : Abnormal DC voltage CTL warning							
9	MPID (reported SSB)							
10	Not used (x'00')							
11	Not used (x'00')							
12	Not used (x'00')							
13	Not used (x'00')							
14	Not used (x'00')							
15	Not used (x'00')							
16	Not used (x'00')							
17	Module ID							
18	Routine ID							
19	PKID				Not used (x'0')			
20	SSID of self subsystem							
21								
22	Symptom code (x'FFFF')							
23								

Format F, Message F (Abnormal MODE : Warning)

	0	1	2	3	4	5	6	7
7	Format (x'F')				Message (x'F')			
8	Subcode : x'41' : Abnormal CEMODE warning							
9	MPID (reported SSB)							
10	Not used (x'00')							
11	Not used (x'00')							
12	Not used (x'00')							
13	Not used (x'00')							
14	Not used (x'00')							
15	Not used (x'00')							
16	Not used (x'00')							
17	Module ID							
18	Routine ID							
19	PKID				Not used (x'0')			
20	SSID of self subsystem							
21								
22	Symptom code (x'FFFF')							
23								

Format F, Message F (CARB error : Warning)

	0	1	2	3	4	5	6	7
7	Format (x'F')				Message (x'F')			
8	Subcode : x'B0' : CARB warning							
9	MPID (reported SSB)							
10	Not used (x'00')							
11	P-PATH No. (x'00' : P-PATH0, x'01' : P-PATH1)							
12	Not used (x'00')							
13	Not used (x'00')							
14	Not used (x'00')							
15	Not used (x'00')							
16	Not used (x'00')							
17	Module ID							
18	Routine ID							
19	PKID				Not used (x'0')			
20	SSID of self subsystem							
21								
22	Symptom code (x'FFFF')							
23								

Format F, Message F (CHM DXBF memory : Correctable error)

	0	1	2	3	4	5	6	7
7	Format (x'F')				Message (x'F')			
8	Subcode : x'01' : CHM DXBF correctable error							
9	MPID (reported SSB)							
10	Not used (x'00')							
11	Not used (x'00')							
12	Not used (x'00')							
13	Not used (x'00')							
14	Not used (x'00')							
15	Not used (x'00')							
16	Not used (x'00')							
17	Module ID							
18	Routine ID							
19	PKID				Not used (x'0')			
20	SSID of self subsystem							
21								
22	Symptom code (x'FFFF')							
23								

Format F, Message F (CHF DXBF memory : Correctable error)

	0	1	2	3	4	5	6	7
7	Format (x'F')				Message (x'F')			
8	Subcode : x'03' : CHF DXBF correctable error							
9	MPID (reported SSB)							
10	Not used (x'00')							
11	Not used (x'00')							
12	Not used (x'00')							
13	Not used (x'00')							
14	Not used (x'00')							
15	Not used (x'00')							
16	Not used (x'00')							
17	Module ID							
18	Routine ID							
19	PKID				Not used (x'0')			
20	SSID of self subsystem							
21								
22	Symptom code (x'FFFF')							
23								

4 ECKD 32-BYTE SSB

4.1 Basic Sense Bytes

The following describes details of 32 ECKD basic sense bytes 0 to 6 and 22 to 31.

		ECKD 32-Byte Sense Data							
		0	1	2	3	4	5	6	7
0	Command rejection	Intervention required	Not used	Device check	Data check	Not used		Incomplete domain	
1	Permanent error	Invalid track format	Not used	Operator message	Not used	File protection	Write inhibit	Imprecise ending	
2	Storage control type								
3	Remaining count; or, command overrun reached threshold *1								
4	Device address								
5	Device type								
6	Unit indication 0: SSB2 1: SSB5	SSB4 valid	SSB29-31 valid	Not used	Format				
7 to 21	Bytes 7 to 21: Depend on the exception class and format. (For details, see Section 4.3.)								
22	Exception class								
23	Exception code; or, CHL#, LPN, and LCP# beyond the threshold *2								
24	Logging message control								
25	Program action code								
26	Dual frame	EDCC Mode	Duplex pair	Subvolume error	Nonsynchronous operation	Serial channel	Report output	Permanent path error	
27	32-byte SSB (0)	Not used			DKU86I TRK compatible mode	Not used	Path number		
28	Message code; or, number of read or searched bytes *3								
29	Cylinder address; or, number of read or searched bytes *3								
30									
31	Head address; or, number of read or searched bytes *3								

: Varies by the exception class and format.

*1 “Remaining count” is for exception class 0 and format 4; otherwise, “Command overrun threshold reached” applies.

*2 “CHL#, LPN, and LCP# beyond the threshold” is for exception class 6; otherwise, “Exception code” is applied.

*2 “Number of read or searched bytes” is for exception class 6.

Otherwise:

Byte 28 = “Message code”

Byte 29-30 = “Cylinder address”

Byte 31 = “Head address”

Common Sense Bytes (ECKD 32-Byte SSB)

ECKD 32-Byte SSB (1/3)

Byte	Bit	Name	Description
0	0	Command rejection	A chain ended without receiving the expected number of data transfer commands in the LR/LRE domain. If no other error is detected, "incomplete domain" (byte 0, bit 7) is also set to 1.
	1	Intervention required	1. The drive is not physically connected. 2. The drive power is off. 3. The ENABLE/DISABLE switch is set to DISABLE.
	2	Not used	
	3	Device check	DKC or drive hardware is abnormal.
	4	Data check	Indicates that a data error has been detected in the information from the drive. This bit is set to 1 when the data error is uncorrectable or error correction is prohibited by the mask byte.
	5	Not used	
	6	Not used	
	7	Incomplete domain	Indicates that as many data transfer commands as defined in the LOCATE RECORD count parameter have not been received.
1	0	Permanent error	Indicates that an error occurred and recovery failed.
	1	Invalid track format	1. The record size parameter is inconsistent with the record to be updated. 2. Nonstandard R0 was detected during branching in Fast Write/Dual Copy operation.
	2	Not used	X'06'
	3	Operator message	Not used for other than DKC SIM. For DKC SIM, indicates that messages are output to the operator
	4	Not used	
	5	File protection	An attempt was made to move to a track not defined in DEFINE EXTENT during execution of the LOCATE RECORD command (updating write in asynchronous mode).
	6	Write inhibit	A write command has been received that uses a resource write-prohibited by the DIAGNOSTIC CONTROL command. "Device check" (byte 0, bit 3) is also set to 1.
	7	Imprecise ending	Indicates that CCW has ended abnormally in the LR/LRE domain and the error is for a previously completed command (whose end status report is already finished).
2	Storage control type/environmental data present	1. For excluding DKC SIM and Cache SIM, this byte indicate DKC type (x'06'). 2. For DKC SIM and Cache SIM, this byte indicate environmental data present (x'10').	
3	Remaining count; or, command overrun threshold reached	When the command overrun threshold is reached in exception class 6: X'01'	Exception class 0 In exception class 0 and format 4: "Remaining count" (number of records/tracks remaining in the LR/LRE domain being handled)
4	Device address	1. When the exception class is 4, 6, B, C, D, or E: Bit 0-1: Storage path number Bit 2: Controller number Bit 3-7: Device number 2. When the exception class is 1, 2, 3, or F: Always '00'	

ECKD 32-Byte SSB (2/3)

Byte	Bit	Name	Description	
5		Device type code	1. For exception class 4, 6, B, C, D and E, this byte indicates device type (x'24'). 2. For exception class 1, 2, 3 and F, always x'00'.	
6		Content and format	Indicates whether the other bytes of SSB are valid or invalid and their formats	
	0	Unit indication	0: SSB2 (storage control type) is valid 1: SSB5 (device type) is valid	
	1	Device address valid	0: SSB4 is invalid 1: SSB4 is valid	
	2	CYL, HD address valid	0: SSB29-31 invalid 1: SSB29-31 valid	
	3	Not used		
	4-7	Format	When x'F', this SSB is SIM.	
22	0-3	Exception class	0: File protection, invalid track format, status exception, command sequence exception 4: Data check, retry prohibition, PCI, subretry success 6: Subsystem data B: Failure between DKC and DASD CTL C: Controller failure (reserved) D: Failure between controller and device E: Device failure	
	4-7		For details, see Section 4.3.	
23		Exception code; or, CHL#, LPN, and LCP# beyond the threshold		
24		(Logging message control)		
	0-2	Not used		
	3	Logging mode	Forced log mode	
	4-5	Logging action	00: Not logged 01: Unconditionally logged 10: Logged only once 11: Logged only for frequent occurrence on the path	
	6-7	Operator message control	00: Message not output 01: Message output unconditionally 10: Message output only once 11: Message output only once only for frequent occurrence on the path	
25	Program action code		Bit 0 = 0	
	Bit 1-7	Single program action code	Bit 1	0 SSBs 26 and 27 have no meaning. 1 Executes error recovery specific to DC.
			2	0 Does not execute ERP based on SSB28. 1 Executes ERP based on SSB28.
			3	Another path retry request
			4-5	Not used
			6-7	00 Does not retry 01 Retry twice 10 Retry ten times 11 Retry 255 times
		Bit 0 = 1		

ECKD 32-Byte SSB (3/3)

Byte	Bit	Name	Description
26 *	0	Dual frame	0: Single-frame configuration 1: Dual-frame configuration
	1	EDCC mode	0: DCC mode 1: EDCC mode
	2	Duplex pair	0: Simplex 1: Duplex pair
	3	Subvolume error	0: Not a subvolume error 1: Subvolume error
	4	Nonsynchronous operation	0: Synchronous operation 1: Asynchronous operation
	5	Serial channel	0: Parallel channel 1: Serial channel
	6	Report output	0: Excluding environmental data present and SIM 1: Environmental data present and SIM
	7	Permanent path error	0: Permanent error for all paths 1: Permanent error for this path
27 *	0	32-byte SSB	ECKD 32-byte SSB = 0
	1-3	Not used	
	4	DKU86I TRK compatible mode	0: Not in DKU86I track compatible mode 1: In DKU86I track compatible mode or changing to DKU86I track compatible mode
	5	Not used	
	6-7	Path number	Indicates the SSB creation path number.
28	Message code		Instructs the message status of the EREP log and operator console.
29	Cylinder address		"Number of read or searched bytes" for exception class 6
30			
31	Head address		
			Indicates the head address with an error.

* Configuration information

4.2 Exception Classes and Formats

Exception class	Format	Description
0	0-1	Reserved
	2	Reserved
	3	Machine condition exception
	4	Command sequence exception
	5-F	Reserved
4	0	Reserved
	1	Data exception (PCI, permanent)*
	2	Reserved
	3-E	Reserved
	F	SIM
6	0	Reserved
	1	Subsystem information*
	2-F	Reserved
B	0	DKC and DASD CTL report error
	1-F	Reserved
D	0	Drive report error*
	1	FPC report error*
	2-E	Reserved
	F	SIM
E	0	Drive failure, LDEV blockade/Pin volume detected/Write inhibited, LDEV not ready*
	1-E	Reserved
	F	SIM

* For DKU87I (IBM 3390 emulation mode) only.

4.3 Details of Sense Bytes

Exception 0, Format 3 (Machine condition exception)

	0	1	2	3	4	5	6	7
6	Unit indication	Byte 4 valid	Bytes 29 to 31 valid	Not used	Format (x'3')			
7	LR/LRE command operation byte							
8	Extension operation byte (byte 17) for LR/LRE command							
9	byte 2 for LR/LRE command							
10	Reserved							
11	Search parameter of LR command (CCHHR) or Record ID of re-execution command (R)							
12								
13								
14								
15	Sector number to re-execute the LR							
16	TLF for LR/LRE command							
17	Operation byte = 0x3F :LR/LRE External operation byte Others :Reserved							
18								
19	SSID							
20	Exception code x'08C1'							
21								
22								
23								

Exception 0, Format 4 (Command sequence exception)

	0	1	2	3	4	5	6	7
6	Unit indication	Byte 4 valid	Bytes 29 to 31 valid	Not used	Format (x'4')			
7	LR/LRE command operation byte							
8	Extension operation byte (byte 17) for LR/LRE command							
9	Head address of extent (DX command parameter)							
10								
11								
12								
13	Path group ID (bytes 1 to 7 of the ID transferred by the newest SET PATH GROUP ID command)							
14								
15								
16								
17								
18	SSID of self subsystem							
19	Exception code x'0212': incomplete domain							
20								
21								
22								
23								

Exception 4, Format 1 (data exception, PCI, permanent)

	0	1	2	3	4	5	6	7
6	Unit indication	Byte 4 valid	Bytes 29 to 31 valid	Not used	Format (x'1')			
7	Sector number*1							
8	Cylinder address*1							
9								
10	Head address*1							
11								
12	Record number*1							
13	Error displacement							
14								
15	Drive serial number							
16	(X'0C24' + DKU sequence number)							
17								
18								
19								
20	SSID of self subsystem							
21								
22	Exception class (x'4')				Message*2			
23	Correction flag*3							

*1 Not determined for occurrence in HA or R0.

*2 Contents of message

x'0': Data check in HA field
 x'1': Data check in C field
 x'2': Data check in K field
 x'3': Data check in D field
 x'4': Missing sink byte in HA field
 x'5': Missing sink byte in C field (PA error)
 x'6': Missing sink byte in K field
 x'7': Missing sink byte in D field
 x'8': Not used
 x'9': Missing AM during retry
 x'A' to x'F': Not used

*2 Contents of correction flag

Bits 0 and 1: CORRECTION BIT
 00: Correctable (Recovered)
 11: Uncorrectable
 Bit 2: Offset active
 Bits 3 to 7: Not used

Exception 6, Format 1 (Subsystem information)

	0	1	2	3	4	5	6	7
6	Unit indication	Byte 4 valid	Bytes 27 to 31 valid	Not used	Format (x'1')			
7	Data overrun threshold exceeded							
8	Seek count							
9								
10	Drive serial number (X '0C24' + DKU sequence number)							
11								
12								
13								
14	DKC serial number (X'0C2400' + DKC sequence number)							
15								
16								
17								
18	SSID of self subsystem							
19								
20								
21	Exception class (x'6')				Exception code (x'F')			
22	0: Statistics or RRBL command 2: Channel data overrun				For parallel/serial channel standard path: CHL#/LPN (0-7) For serial channel extension path: LCP number			
23								

Exception B, Format 0 Exception code 1 (Shared Memory Failure)

	0	1	2	3	4	5	6	7
6	Unit indication	Byte 4 valid	Bytes 29 to 31 valid	Not used	Format (x'0')			
7	0x81							
8	Subcode (F/M = 81 SSB Byte 8)							
9	F/M = 81 SSB Byte 9							
10	Module ID (F/M = 81 SSB Byte 18)							
11	Routine ID (F/M = 81 SSB Byte 19)							
12	Internal SSB Serial number							
13								
14	F/M = 81 SSB Byte 10							
15	Drive serial number (X'0C24' + DKU sequence number)							
16								
17								
18								
19	SSID							
20								
21	Exception class (0xB)/Exception code (0x1)							
22	Exception code (F/M = 81 SSB Byte 20:Processor#/Message code)							
23								

Exception B, Format 0 Exception code 8 (LCP/MCP Failure)

	0	1	2	3	4	5	6	7
6	Unit indication	Byte 4 valid	Bytes 29 to 31 valid	Not used	Format (x'0')			
7	0x88							
8	LCP Error Code (F/M = 88 SSB Byte 9)							
9	LCP Error Code (F/M = 88 SSB Byte 10)							
10	Module ID (F/M = 88 SSB Byte 18)							
11	Routine ID (F/M =88 SSB Byte 19)							
12	Internal SSB Serial number							
13								
14	LCP Error Message (F/M = 88 SSB Byte 8)							
15	Drive serial number (X'0C24' + DKU sequence number)							
16								
17								
18								
19								
20	SSID							
21								
22	Exception class (0xB)/Exception code (0x8)							
23	Exception code (F/M = 88 SSB Byte 20:Processor#/Message code)							

Exception B, Format 0 Exception code 9 (Host Adapter CHK2)

	0	1	2	3	4	5	6	7
6	Unit indication	Byte 4 valid	Bytes 29 to 31 valid	Not used	Format (x'0')			
7	0x89							
8	Subcode (F/M = 89 SSB Byte 8)							
9	F/M = 89 SSB Byte 9							
10	Module ID (F/M = 89 SSB Byte 18)							
11	Routine ID (F/M =89 SSB Byte 19)							
12	Internal SSB Serial number							
13								
14	Error ID Code *1							
15	Drive serial number (X'0C24' + DKU sequence number)							
16								
17								
18								
19								
20	SSID							
21								
22	Exception class (0xB)/Exception code (0x9)							
23	Exception code (F/M = 89 SSB Byte 20:Processor#/Message code)							

Exception B, Format 0 Exception code A (Disk Adapter CHK2)

	0	1	2	3	4	5	6	7
6	Unit indication	Byte 4 valid	Bytes 29 to 31 valid	Not used	Format (x'0')			
7	0x8A							
8	Subcode (F/M = 8A SSB Byte 8)							
9	F/M = 8A SSB Byte 9							
10	Module ID (F/M = 8A SSB Byte 18)							
11	Routine ID (F/M = 8A SSB Byte 19)							
12	Internal SSB Serial number							
13								
14	Error ID Code *1							
15	Drive serial number (X'0C24' + DKU sequence number)							
16								
17								
18								
19								
20	SSID							
21								
22	Exception class (0xB)/Exception code (0xA)							
23	Exception code (F/M = 8A SSB Byte 20:Processor#/Message code)							

*1

ID Code	Sense
0x20	LA Error
0x10	LRC Error
0x00	Other Error

Exception B, Format 0 Exception code B (DRR CHK2)

	0	1	2	3	4	5	6	7
6	Unit indication	Byte 4 valid	Bytes 29 to 31 valid	Not used	Format (x'0')			
7	0x8B							
8	Subcode (F/M = 8B SSB Byte 8)							
9	F/M = 8B SSB Byte 9							
10	Module ID (F/M = 8B SSB Byte 18)							
11	Routine ID (F/M = 8B SSB Byte 19)							
12	Internal SSB Serial number							
13								
14	Error ID Code *1							
15	Drive serial number (X'0C24' + DKU sequence number)							
16								
17								
18								
19								
20	SSID							
21								
22	Exception class (0xB)/Exception code (0xB)							
23	Exception code (F/M = 8B SSB Byte 20:Processor#/Message code)							

*1

ID Code	Sense
0x10	LRC Error
0x00	Other Error

Exception B, Format 0 Exception code D (Power Failure)

	0	1	2	3	4	5	6	7
6	Unit indication	Byte 4 valid	Bytes 29 to 31 valid	Not used	Format (x'0')			
7	0x8D							
8	Subcode (F/M = 8D SSB Byte 8)							
9	F/M = 8D SSB Byte 9							
10	F/M = 8D SSB Byte 10							
11	F/M = 8D SSB Byte 11							
12	Internal SSB Serial number							
13								
14	F/M = 8D SSB Byte 18							
15	Drive serial number (X'0C24' + DKU sequence number)							
16								
17								
18								
19								
20	SSID							
21								
22	Exception class (0xB)/Exception code (0xD)							
23	Exception code (F/M = 8D SSB Byte 20:Processor#/Message code)							

Exception B, Format 0 Exception code E (Power Failure)

	0	1	2	3	4	5	6	7
6	Unit indication	Byte 4 valid	Bytes 29 to 31 valid	Not used	Format (x'0')			
7	0x8E							
8	F/M = 8E SSB Byte 8							
9	F/M = 8E SSB Byte 9							
10	Module ID (F/M = 8E SSB Byte 18)							
11	Routine ID (F/M = 8E SSB Byte 19)							
12	Internal SSB Serial number							
13								
14	F/M = 8E SSB Byte 10							
15	Drive serial number (X'0C24' + DKU sequence number)							
16								
17								
18								
19								
20	SSID							
21								
22	Exception class (0xB)/Exception code (0xE)							
23	Exception code (F/M = 8E SSB Byte 20:Processor#/Message code)							

Exception B, Format 0 Exception code E (Selective Reset Notification/Wait Sense Time Over)

	0	1	2	3	4	5	6	7
6	Unit indication	Byte 4 valid	Bytes 29 to 31 valid	Not used	Format (x'0')			
7	0x8E							
8	F/M = 8E SSB Byte 8							
9	F/M = 8E SSB Byte 9							
10	Lost SSB's Module ID (F/M = 8E SSB Byte 14)							
11	Lost SSB's Routine ID (F/M = 8E SSB Byte 15)							
12	Internal SSB Serial number							
13								
14	F/M = 8E SSB Byte 10							
15	Drive serial number (X'0C24' + DKU sequence number)							
16								
17								
18								
19								
20	SSID							
21								
22	Exception class (0xB)/Exception code (0xE)							
23	Exception code (F/M = 8E SSB Byte 20:Processor#/Message code)							

Exception B, Format 0 Exception code F (Logical inconsistency)

	0	1	2	3	4	5	6	7
6	Unit indication	Byte 4 valid	Bytes 29 to 31 valid	Not used	Format (x'0')			
7	0x8F							
8	Module ID (F/M = 8F SSB Byte 8)							
9	Routine ID (F/M = 8F SSB Byte 9)							
10	F/M = 8F SSB Byte 10							
11	F/M = 8F SSB Byte 11							
12	Internal SSB Serial number							
13								
14	F/M = 8F SSB Byte 12							
15	Drive serial number (X'0C24' + DKU sequence number)							
16								
17								
18								
19								
20	SSID							
21								
22	Exception class (0xB)/Exception code (0xF)							
23	Exception code (F/M = 8F SSB Byte 20:Processor#/Message code)							

Exception D, Format 1 (FPC report error)

	0	1	2	3	4	5	6	7
6	Unit indication	Byte 4 valid	Bytes 29 to 31 valid	Not used	Format (x'1')			
7	Type code ('111') (FPC report error)			Not used	Reserved			
8								
9								
10	SCSI command code (See SSB04-150)							
11	Threshold type (See SSB04-270)							
12	Module ID							
13	Routine ID							
14	Not used							
15	Drive serial number (X'0C24' + DKU sequence number)							
16								
17								
18								
19								
20	SSID of self subsystem							
21								
22	Exception class (x'D')				CDEV No.			
23	RDEV No.							

Exception D, Format 0 (drive report error)

	0	1	2	3	4	5	6	7
6	Unit indication	Byte 4 valid	Bytes 29 to 31 valid	Not used	Format (x'0')			
7	Type code ('000') (drive report error)			Not used	Sense key*1			
8	Additional Sense Code+Additional Sense Code Qualifier							
9								
10	SCSI command code*2							
11	Threshold type							
12	Module ID							
13	Routine ID							
14	Not used							
15	Drive serial number (X'0C24' + DKU sequence number)							
16								
17								
18								
19								
20	SSID of self subsystem							
21								
22	Exception class (x'E')				CDEV No.			
23	RDEV No.							

*1 Sense key

x'0' : NO SENSE
 x'1' : RECOVERED
 x'2' : NOT READY
 x'3' : MEDIUM ERROR
 x'4' : HARDWARE ERROR
 x'5' : ILLEGAL REQUEST
 x'6' : UNIT ATTENTION
 x'7' : DATA PROTECT
 x'8' : BLANK CHECK (Not used)
 x'9' : VENDOR UNIQUE (Not used)
 x'A' : COPY ABORTED (Not used)
 x'B' : ABORTED COMMAND
 x'C' : EQUAL (Not used)
 x'D' : VOLUME OVERFLOW (Not used)
 x'E' : MISCOMPARE
 x'F' : (RESERVED)

*2 SCSI command

x'00' : TEST UNIT READY
 x'03' : REQUEST SENSE
 x'04' : FORMAT UNIT
 x'07' : REASSIGN BLOCKS
 x'12' : INQUIRY
 x'15' : MODE SELECT
 x'1A' : MODE SENSE
 x'1B' : START/STOP UNIT
 x'1C' : RECEIVE DIAGNOSTIC RESULT
 x'1D' : SEND DIAGNOSTIC
 x'28' : READ (EXTEND)
 x'2A' : WRITE (EXTEND)
 x'2E' : WRITE AND VERIFY
 x'3B' : WRITE BUFFER

Exception E, Format 0 (drive report error)

	0	1	2	3	4	5	6	7
6	Unit indication	Byte 4 valid	Bytes 29 to 31 valid	Not used	Format (x'0')			
7	Type code ('000') (drive report error)			Not used	Sense key*1			
8	Additional Sense Code+Additional Sense Code Qualifier							
9								
10	SCSI command code*2							
11	Threshold type							
12	Module ID (≠ x'5X/6X')							
13	Routine ID							
14	Not used							
15	Drive serial number (X'0C24' + DKU sequence number)							
16								
17								
18								
19								
20	SSID of self subsystem							
21								
22	Exception class (x'E')				CDEV No.			
23	RDEV No.							

*1 Sense key

x'0' : NO SENSE
 x'1' : RECOVERED
 x'2' : NOT READY
 x'3' : MEDIUM ERROR
 x'4' : HARDWARE ERROR
 x'5' : ILLEGAL REQUEST
 x'6' : UNIT ATTENTION
 x'7' : DATA PROTECT
 x'8' : BLANK CHECK (Not used)
 x'9' : VENDOR UNIQUE (Not used)
 x'A' : COPY ABORTED (Not used)
 x'B' : ABORTED COMMAND
 x'C' : EQUAL (Not used)
 x'D' : VOLUME OVERFLOW (Not used)
 x'E' : MISCOMPARE
 x'F' : (RESERVED)

*2 SCSI command

x'00' : TEST UNIT READY
 x'03' : REQUEST SENSE
 x'04' : FORMAT UNIT
 x'07' : REASSIGN BLOCKS
 x'12' : INQUIRY
 x'15' : MODE SELECT
 x'1A' : MODE SENSE
 x'1B' : START/STOP UNIT
 x'1C' : RECEIVE DIAGNOSTIC RESULT
 x'1D' : SEND DIAGNOSTIC
 x'28' : READ (EXTEND)
 x'2A' : WRITE (EXTEND)
 x'2E' : WRITE AND VERIFY
 x'3B' : WRITE BUFFER

SCSI sense key

Sense key	Definition
0 _H	NO SENSE: Indicates that the key information reported from the specified logical unit is not for specific use. This indicates that the command has ended normally.
1 _H	RECOVERED ERROR: Indicates that the last command has ended normally after recovery operation by the controller. Details can be determined by checking the additional sense byte and information byte.
2 _H	NOT READY: Indicates that the addressed logical unit cannot be accessed. Recovery from this status may require operator's intervention.
3 _H	MEDIUM ERROR: Indicates that the command has ended in the irrecoverable error status due to damage to the medium or an error in recorded data.
4 _H	HARDWARE ERROR: Indicates that the controller has detected an irrecoverable hardware error (e.g., controller failure, device failure, parity error, etc.) during execution of a command or self-diagnostics.
5 _H	ILLEGAL REQUEST: Indicates that illegal data has been detected in the CDB or the additional parameter given as data for some commands (FORMAT UNIT, MODE SELECT, etc.). The controller terminates the command without changing the medium if an invalid parameter has been detected in the CDB. If an invalid parameter has been detected in the additional parameter given as data, the medium may already have been changed.
6 _H	UNIT ATTENTION: Indicates that the unit attention status has occurred because the MODE SELECT parameter has been changed or the controller has been reset.
7 _H	DATA PROTECT: Indicates that a write command has been received when write to media is prohibited. Write operation is not performed.
8 _H	BLANK CHECK. (Not used)
9 _H	Vendor Unique. (Not used)
A _H	COPY ABORTED. (Not used)
B _H	ABORTED COMMAND: Indicates that the controller has aborted the command. The host can retry the command for recovery.
C _H	EQUAL. (Not used)
D _H	VOLUME OVERFLOW. (Not used)
E _H	MISCOMPARE: Data comparison failed during byte comparison and verification. Or, data in the WRITE BUFFER command from the same host was changed before execution of the READ BUFFER command.
F _H	Reserved

Additional sense code

Code	Description
00	No Additional Sense Information
01	No Index/Sector Signal
02	No Seek Complete
03	Write Fault
04	Drive Not Ready
05	Drive Not Selected
06	No Track Zero Found
07	Multiple Drives Selected
08	Logical Unit Communication Failure
09	Track Following Error
0A	Error Log Overflow
0B	Warning
0C	Write Error
10	ID CRC Error
11	Unrecovered Read Error
	Read Retries Exhausted
	Error Too Long to Correct
	Unrecovered Read Error-Auto Reallocation Failed
	Error Too Long to Multi-Symbol Soft Correction
12	No Address Mark Found in ID Field
13	No Address Mark Found in Data Field
14	Recorded Entity Not Found
	Reassign Fault because of Reserve Sector No REC
	Previous Sector Error with Previous Sector ID retry
	Error too much to recover using previous ID
	ID On the Fly Correction Error
	VFO ID Error Recovered (Read Gate Delay:4, PLL:8)
	VFO ID Error Recovered (Read Gate Delay:0, PLL:6)
VFO ID Error Recovered (Read Gate Delay:8, PLL:6)	
15	Mechanical Positioning Error
16	Data Synchronization Mark Error
17	Recovered Data with No Error Correction Applied
18	Recovered Data with Error Correction Applied
19	Defect List Error
1A	Parameter List Length Error
1B	Synchronous Data Transfer Error
1C	Defect List Not Found
1D	Miscompare During Verify Operation
1E	Recovered ID With ECC Correction
1F	Partial Defect List Transfer
20	Invalid Command Operation Code
21	Logical Block Address out of Range
24	Illegal Field in CDB
	Odd Byte Data Out Request in Wide Transfer
	Odd Byte Data Out Request

Code	Description
25	Invalid LUN
26	Invalid Field in Parameter List
27	Write Protected
28	Not Ready To Ready Transition
29	Power On Reset Occurred
2A	Parameter Changed
2B	Copy Cannot Execute Since Host Cannot Disconnect
2C	Command Sequence Error
2F	Command Cleared by Another Initiator
30	Incompatible Medium Installed
31	Medium Format Corrupted
32	No Defect Spare Location Available
34	Enclosure Failure
35	Enclosure Services Failure
37	Rounded Parameter
39	Saving Parameters Not Supported
3D	Invalid Bits in Identify Message
3E	Logical Unit Has Not Self-Configured Yet.
3F	Target Operating Conditions Have Changed
40	RAM Failure
41	Data Path Failure In Diagnostic
42	Power On or Self test Failure
43	Message Error
44	Internal Target Failure
45	Select/Reselect Failed
47	Data Transfer Error
48	Initiator Detected Error
49	Invalid Message Error
4A	Command Phase Error
4B	Data Phase Error
4C	Logical Unit Failed Self-Configured
4D	Tagged Overlapped Commands
4E	Overlapped Commands Attempted
55	System Buffer Full
5B	Log Exception
5C	RPL Status Change
5D	Failure Prediction Threshold Exceeded
5E	Low Power Condition On
65	Voltage Fault
80-FF	Vendor - Specific

Blank Sheet

REV.0	Jun.2001					
-------	----------	--	--	--	--	--

Blank Sheet

REV.0	Jun.2001					
-------	----------	--	--	--	--	--

Blank Sheet

REV.0	Jun.2001					
-------	----------	--	--	--	--	--

Blank Sheet

REV.0	Jun.2001					
-------	----------	--	--	--	--	--

Blank Sheet

REV.0	Jun.2001					
-------	----------	--	--	--	--	--

Blank Sheet

REV.0	Jun.2001					
-------	----------	--	--	--	--	--

Blank Sheet

REV.0	Jun.2001					
-------	----------	--	--	--	--	--

Threshold type

Code	Threshold (failure) type	Code	Threshold (failure) type
00	CHA CHK1A	30	Cache 1 bit correctable error
01	CHA CHK1B	31	Cache uncorrectable error
02	CHA CHK3	32	Cache 2 bits correctable error
03	CHA CHK2	33	CPC check error
04	CHA ADP temporary error	40	SCSI port failure
05	LCM hardware error	41	Drive mechanism recovered error
06	BSA F bus open	42	Drive mechanism unrecovered error
07	BSA LIVEINS	43	Drive media recovered error
08	BSA check error	44	Drive media unrecovered error
09	SMP M bus open	45	Drive R/W recovered error
0A	SMP M bus check error	46	Drive R/W unrecovered error
0B	SMP H/L check error	47	Drive interface recovered error
10	DKA CHK1A	48	Drive interface unrecovered error
11	DKA CHK1B	49	Controller recovered error
12	DKA CHK3	4A	Controller unrecovered error
13	DKA SCA temporary error	4B	SCSI interface recovered error
14	DKA DRR temporary error	4C	SCSI interface unrecovered error
16	BSA F bus open	4D	Drive I/O read error
17	BSA LIVEINS	4E	Drive I/O write error
18	BSA check error	60	SVP interface error
19	SMP M bus open	FF	Invalid threshold type
1A	SMP M bus check error		
1B	SMP H/L check error		
20	Shared memory correctable error		
21	Shared memory uncorrectable error		
22	SMC M bus open		
23	SMC H/L bus open		

Exception E, Format 0 (LDEV blockade/Pin volume detected/Write inhibited) (Note 1)

	0	1	2	3	4	5	6	7
6	Unit indication	Byte 4 valid	Bytes 29 to 31 valid	Not used	Format (x'0')			
7	Type Code ('000')			Not used				
8	Ready	Enable	SSB pending	Not used				
9	Not used							
10	Media maintenance reserve	Pin volume	Write inhibited	Not used				
11	Not used							
12	Module ID (Note 2)							
13	Routine ID (Note 2)							
14	Not used							
15	Drive serial number (x'0C24' + DKU sequence number)							
16								
17								
18								
19	SSID of self subsystem							
20								
21	Exception code (x'E000')							
22								
23								

(Note 1) Byte 0, Bit 3 (device check) is set to 1.

(Note 2) Module ID · Routine ID

x'5011/501C/5202'	; LDEV blockade
x'501A/501B'	; PIN volume detected
x'6605/6697/6705/6784/6805/6853/6909/6953'	; Write inhibited

Exception E, Format 0 (LDEV not ready) (Note 1)

	0	1	2	3	4	5	6	7
6	Unit indication	Byte 4 valid	Bytes 29 to 31 valid	Not used	Format (x'2')			
7	Type Code ('000')			Not used	Not used			
8	Ready	Enable	SSB pending	0	0	0	0	0
9	x'00'							
10	Media maintenance reserve	Pin volume	0	0	0	0	0	0
11	Host type	DKC type	0	0	DKU type			
12	Module ID (x'50'/x'52')							
13	Routine ID (x'1C'/x'02')							
14	Not used							
15	Drive serial number (x'0C24' + DKU sequence number)							
16								
17								
18								
19	SSID of self subsystem							
20								
21	Exception code (x'E210')							
22								
23								

(Note 1) Byte 0, bit 1 (intervention required) is set to 1.