



**Hitachi Freedom Storage™
Thunder 9500™ V Series**

**SANtinel 9500V
User's Guide**

© 2003 Hitachi Data Systems Corporation,, ALL RIGHTS RESERVED

Notice: No part of this publication may be reproduced or transmitted in any form or by any electronic or mechanical means, including photocopying and recording, or stored in a database or retrieval system for any purpose, without the express written permission of Hitachi Limited.

Hitachi reserves the right to make changes to this document at any time without notice and assumes no responsibility for its use. Hitachi products or services can only be ordered under the terms and conditions of Hitachi's applicable agreements, including license agreements. All of the features described in this document may not be currently available. Refer to the most recent product announcement or contact your local Hitachi sales office for information on feature and product availability.

This document contains the most current information available at the time of publication. When new and/or revised information becomes available, this entire document will be updated and distributed to all registered users.

Trademarks

Hitachi Data Systems is a registered trademark and service mark of Hitachi, Ltd., and the Hitachi Data Systems design mark is a trademark and service mark of Hitachi, Ltd.

Freedom Storage and Thunder 9500 V are trademarks of Hitachi Data Systems Corporation.

HP and HP-UX are registered trademarks of the Hewlett-Packard Company.

JNI is a trademark of JNI Corporation.

IBM is a registered trademark of the International Business Machines Corporation.

Microsoft, Windows, Windows NT, and the Windows logo are either registered trademarks or trademarks of Microsoft Corporation in the United States and/or other countries.

SGI is a trademark of Silicon Graphics, Inc.

Solaris is a trademark or registered trademark of SUN Microsystems, Inc.

All other brand or product names are or may be trademarks or service marks of and are used to identify products or services of their respective owners.

Notice of Export Controls

Export of technical data contained in this document may require an export license from the United States government and/or the government of Japan. Contact the Hitachi Legal Department for any export compliance questions.

Document Revision Level

Revision	Date	Description
MK-92DF613-P	September 2002	Preliminary Release
MK-92DF613-0	November 2002	Revision 0, supersedes and replaces MK-92DF613-P
MK-92DF613-1	January 2003	Revision 1, supersedes and replaces MK-92DF613-0
MK-92DF613-2	February 2003	Revision 2, supersedes and replaces MK-92DF613-1

Source Documents Used in this Revision

The following source documents were used to produce this guide:

- LUN Security 9470 User's Guide, (LUNSecurity_0E, dated 8/01/02).
- LUN Security User's Guide (DF600), (LUNSecurity_0E, dated 8/01/02).
- Review of the HDS published SANTinel 9500V User's Guide (mp-92df613-2, dated 1/20/03).

Changes in this Revision

- Updated Table 1.1 regarding inability to use LUN Management concurrently.
- Added note to section 1.3 regarding WWN Setup by LUN.
- Deleted the note dealing with "Do not manually power off the array unit." in step 7 of Chapter 3.
- Deleted the Restart Successful Message figure in step 7 of Chapter 3.
- Updated Figure 4.3, Security Property panel.
- Updated Figure 4.10, Security Property Panel.
- Updated section B.2.5 regarding the Emulex method of obtaining WWN of a host.
- Updated section B.2.5.1 regarding the Port Driver.
- Updated section B.2.5.2 regarding the EmulexSCSI Miniport Driver.

Referenced Documents

- *9500V User and Reference Manual* (MK-92DF601)
- *Resource Manager 9500V User's Guide for GUI* (MK-92DF605)
- *Resource Manager 9500V User's Guide for CLI* (MK-92DF603)

Preface

This user's guide provides instructions for installing and using SANTinel 9500V. You should read the operating procedures and notices included in this guide before using SANTinel 9500V.

The *SANTinel 9500V User's Guide* assumes that:

- The user has a background in data processing and understands direct-access storage device subsystems and their basic functions.
- The user is familiar with the Hitachi Disk array subsystem.
- The user is familiar with the *Resource Manager 9500V (for GUI) User's Guide* and/or the *Resource Manager 9500V (for CLI) User's Guide*.
- The user is familiar with the Windows® operating system.

Note: When you replace the Host Bus Adapter (HBA) of the host (server) with the system using SANTinel 9500V, you need to change the setting of SANTinel 9500V (see section 4.6 - Changing the WWN of the Host HBA).

For additional information on the 9500V subsystem features and functions, please contact your Hitachi Data Systems account team, or visit Hitachi Data Systems online at <http://www.hds.com>.

Note: The use of Hitachi Resource Manager, the SANTinel software, and all other Hitachi Data Systems products is governed by the terms of your license agreement(s) with Hitachi Data Systems.

Note: The screens shown in this document were captured on a Windows® system with the Internet Explorer web browser. The screens may display differently on other operating systems and browsers. Please refer to the *Resource Manager 9500 User's Guide for GUI* (MK-92DF605) for further information on other operating systems and browsers.

Note: The term "9500V" refers to the entire Hitachi Freedom Storage™ Thunder 9500™ V Series subsystem family, unless otherwise noted.

Note: The term "DF600" refers to the 9500V subsystem, unless otherwise noted.

Note: The term "LUN Security" refers to SANTinel, unless otherwise noted.

COMMENTS

Please send us your comments on this document: doc.comments@hds.com.

Make sure to include the document title, number, and revision.

Please refer to specific page(s) and paragraph(s) whenever possible.

(All comments become the property of Hitachi Data Systems Corporation.)

Thank you!

Contents

Chapter 1	Overview of SANTinel 9500V	1
1.1	Functional Overview.....	1
1.2	Specifications.....	2
1.3	Notes on Setting SANTinel 9500V Information	3
Chapter 2	Installing and Uninstalling SANTinel 9500V (GUI)	5
2.1	Installing SANTinel 9500V	5
2.2	Uninstalling SANTinel 9500V	8
Chapter 3	Enabling or Disabling SANTinel 9500V (GUI)	9
Chapter 4	Browsing and Setting SANTinel 9500V Information (GUI).....	13
4.1	Host Identification Information.....	13
4.2	Access Check Required Information	14
4.3	Setting the Security Information	15
4.4	Deleting the WWN of the Host HBA	20
4.5	Deleting the WWN Accessible for Each LUN	21
4.6	Changing the WWN of the Host HBA (Changing the WWN when the host HBA is replaced)	22
Chapter 5	Troubleshooting.....	23
5.1	Troubleshooting.....	23
5.2	Calling the Hitachi Data Systems Technical Support Center	23
Appendix A	SANTinel Operations Using CLI	25
A.1	Installing SANTinel 9500V	25
A.2	Uninstalling SANTinel 9500V	26
A.3	Enabling or Disabling SANTinel 9500V.....	27
A.4	Browsing and Setting SANTinel 9500V Information.....	28
A.4.1	Host Identification Information	28
A.4.2	Access Check Necessity Information.....	28
A.4.3	Setting the Security Information	29
A.4.4	Deleting the WWN of the Host HBA	31
A.4.5	Deleting the WWN Accessible for Each LUN	31
A.4.6	Changing the WWN of the Host HBA (Changing the WWN when the host HBA is replaced)	32

Appendix B Using the WWN Change Operation when the HBA is Replaced	33
B.1 WWN Change Procedure when the HBA is Replaced	33
B.2 Obtaining the WWN of a Host	33
B.2.1 Solaris™	34
B.2.2 HP®	36
B.2.3 IBM®	39
B.2.4 SGI™	40
B.2.5 Windows NT®/ Windows® 2000	41
Acronyms and Abbreviations.....	45
Index.....	47

List of Figures

Figure 1.1	SANtinel 9500V Functional Overview	1
Figure 2.1	Array System Viewer Panel.....	5
Figure 2.2	Parameter Panel	6
Figure 2.3	The Unlock Confirmation Request Message.....	6
Figure 2.4	The Unlock Confirmation Message	7
Figure 2.5	Parameter Panel (Options tab: unlocked: Enable)	7
Figure 2.6	Lock Confirmation Request Message.....	8
Figure 2.7	Locked Confirmation Message	8
Figure 3.1	Array System Viewer Panel.....	9
Figure 3.2	Parameter Panel (Options tab: No Option)	10
Figure 3.3	Enable/Disable Request Confirmation Message.....	10
Figure 3.4	Confirmation Message.....	10
Figure 3.5	Option Verification	11
Figure 4.1	Array System Viewer Panel.....	15
Figure 4.2	Array System Viewer Panel (Setting Security Information)	16
Figure 4.3	Security Property Panel	16
Figure 4.4	WWN Dialog Box	17
Figure 4.5	Node Name Entry	17
Figure 4.6	LUN Security Panel (Selecting Security Check Level, Logical Unit No., and Node Name)	17
Figure 4.7	LUN Security Panel (Selecting Security Check Level and Logical Unit)	18
Figure 4.8	Setting Ended Confirmation Message	18
Figure 4.9	Security Information List	19
Figure 4.10	Security Property Panel (Delete the WWN of the Host HBA)	20
Figure 4.11	Selecting the WWN to Delete	21
Figure 4.12	WWN Dialog Box	22
Figure A.1	Security Information List	30

List of Tables

Table 1.1	SANtinel 9500V Specifications	2
Table 4.1	Host Identification Item Status.....	14
Table A.1	Host Identification Item Status.....	28

Chapter 1 Overview of SANtinel 9500V

1.1 Functional Overview

The SANtinel 9500V feature enables specific hosts to access arbitrary Logical Unit Numbers (LUNs). This feature prevents data from damage caused by illegal access in a storage-area network (SAN) environment. By using a host's World Wide Name (WWN), you can set a Logical Unit Number (LUN) to communicate only with specific WWN(s); this allows you to limit access to that LUN from specific host(s). When WWNs are specified, the hosts assume that only permitted LUNs are connected to these hosts. Figure 1.1 presents a functional overview of the SANtinel 9500V.

The major functions of the SANtinel 9500V are:

- The SANtinel 9500V enables the user to specify or change LUN accessibility for each selected host from Resource Manager 9500V.
- Once specified, the SANtinel 9500V allows the host to recognize only the specified Logical Units (LUs).

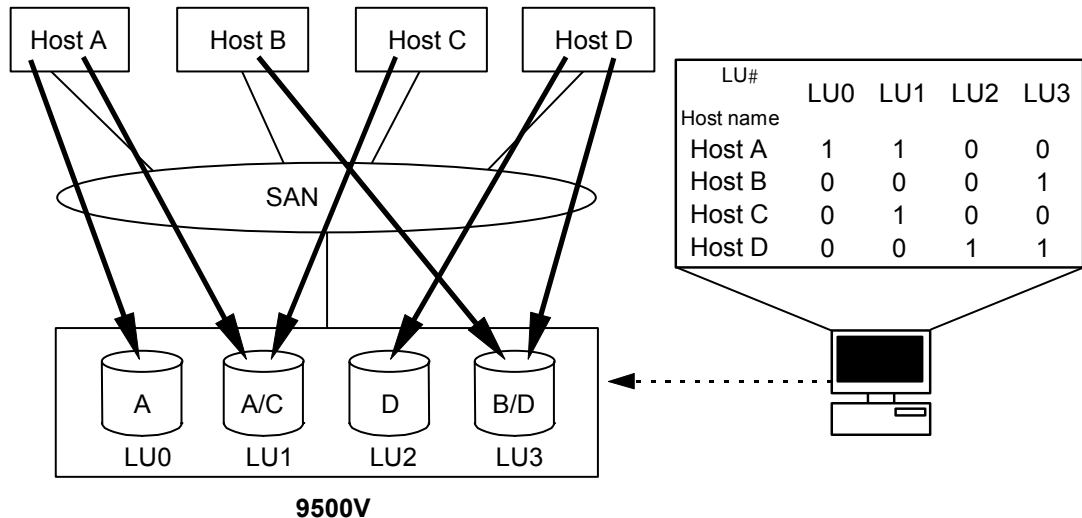

Figure 1.1 SANtinel 9500V Functional Overview

1.2 Specifications

The specifications of SANTinel 9500V are listed in Table 1.1:

Table 1.1 SANTinel 9500V Specifications

Item	Specifications
Available LUNs	Units can be specified if they already have the SANTinel 9500V as a licensed feature.
Number of WWNs to be Registered	Up to 128 WWNs of hosts for a port can be registered.
Security Setting	Specify one or more WWNs that can access LUNs. <ul style="list-style-type: none">• You can specify 2 or more WWNs for each LUN.• If a LUN mapping function is used, security can be set up for every port. Furthermore, LUN Security (SANTinel) can also set up security for every WWN in the same port.
WWN Change	You can change the WWN access without disrupting the security settings. <ul style="list-style-type: none">• The WWN change function is effective when you have to change the WWN; for example, when you replace a HBA of a specific host.
SANTinel 9500V Enable/Disable	SANTinel 9500V can be enabled or disabled for each port. You can also disable SANTinel 9500V temporarily. <ul style="list-style-type: none">• The security information that has been set is retained while LUN Security is disabled. It can be restored when SANTinel 9500V is enabled again.• Since SANTinel 9500V is disabled when it is initially installed, the system can easily be operated.
Security level of the SANTinel Control Feature	When using the SANTinel Control Feature, you can select either "Check INQUIRY" or "Check All Commands" as a security level. <ul style="list-style-type: none">• The "Check INQUIRY" option specifies checking the access made to LUs with an INQUIRY command (one of the SCSI commands).• The "Check All Commands" option specifies checking the access made to LUs with all the SCSI commands individually.
Setting in a hot replacement	Security can be set up from the Resource Manager 9500V without rebooting the array unit.
Concurrent us of LUN Management	Cannot use LUN Management concurrently.

1.3 Notes on Setting SANTinel 9500V Information

- Verify that the SANTinel 9500V setting information is correct and accurate. The settings must be correct for the system to run smoothly. For details, refer to *Resource Manager 9500V User's Guide for GUI (MK-92DF605)*.
- This function is not available when a host (OS or driver) cannot identify an LU without LUN#0 or when a host cannot identify LUs after an undefined LU is found (when "Inquiry" is not issued).
- When you replace the HBA of the host (server) attached to a 9500V using SANTinel 9500V, be sure to change the setting of the SANTinel 9500V. For details, see section 4.6 Changing the WWN of the Host HBA.
- When changing the security level on a SANTinel 9500V feature from "Check INQUIRY" to "Check All Commands," and vice versa, stop I/O operations from a host that is already registered in the WWN permitted to access the SANTinel information of the port concerned, and then change the setting.
- SANTinel 9500V settings (enabling or disabling) are valid after the host is recognized again. **Note:** The settings are not valid immediately after the setting. To make the setting valid, reboot the host (to be recognized again).
- The WWN set up by LUN Management is taken over to LUN Security.

Chapter 2 Installing and Uninstalling SANTinel 9500V (GUI)

This section includes the following:

- Installing SANTinel 9500V
- Uninstalling SANTinel 9500V

2.1 Installing SANTinel 9500V

The SANTinel 9500V feature is usually unselectable (locked). To make this feature available, you must install SANTinel 9500V and make its functions selectable (unlocked). To install this function, use the key code provided with the optional feature.

SANTinel 9500V is installed and uninstalled through the Resource Manager 9500V.

Note: Before installing and uninstalling, make sure that the array unit is in normal operating mode (for details, refer to *Resource Manager 9500V User's Guide for GUI (MK-92DF605)*). If a failure such as a controller blockade has occurred, installation and uninstallation operations cannot be performed.

To install SANTinel 9500V using the GUI version of Resource Manager 9500V:

1. Start Resource Manager 9500V and change to **Management Mode**. For details, refer to the *Resource Manager 9500V User's Guide for GUI (MK-92DF605)*.
2. Register the array unit in which you will install SANTinel 9500V and connect to this array unit. For details, refer to *Resource Manager 9500V User's Guide for GUI (MK-92DF605)*.

The Array System Viewer panel appears and displays the connected subsystem (see Figure 2.1)

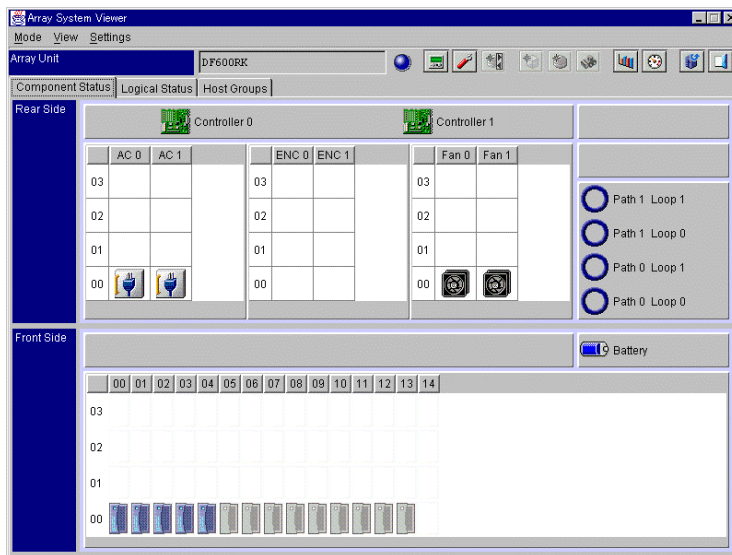



Figure 2.1 Array System Viewer Panel

3. From the **Settings** menu, select **Configuration Settings**. Alternatively, from the tool bar, select the **Configuration Settings**  button.
4. From the resulting Parameter panel, click the **Options** tab (see Figure 2.2).

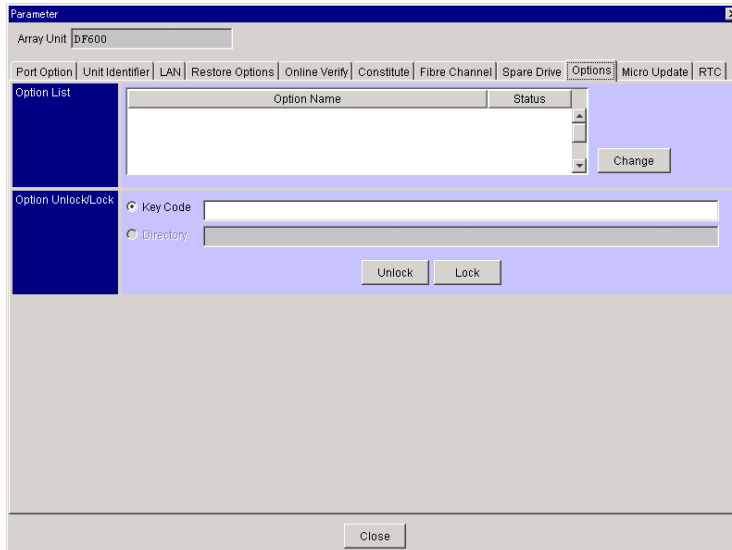

Figure 2.2 Parameter Panel

5. Enter a key code in the text box and click the **Unlock** button.
6. A message appears, requesting a confirmation to unlock the SANTinel 9500V feature. Click the **OK** button (see Figure 2.3).

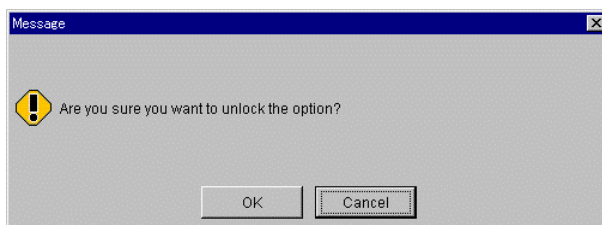

Figure 2.3 The Unlock Confirmation Request Message

7. A message appears, confirming that this optional feature is unlocked. Click the **OK** button (see Figure 2.4).

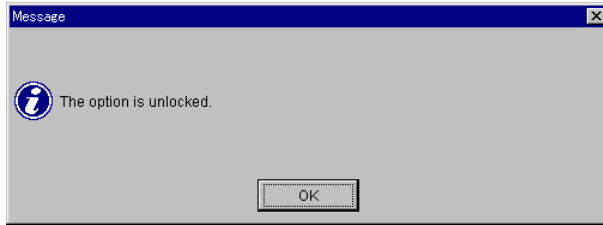

Figure 2.4 The Unlock Confirmation Message

The updated Parameter panel appears (see Figure 2.5).

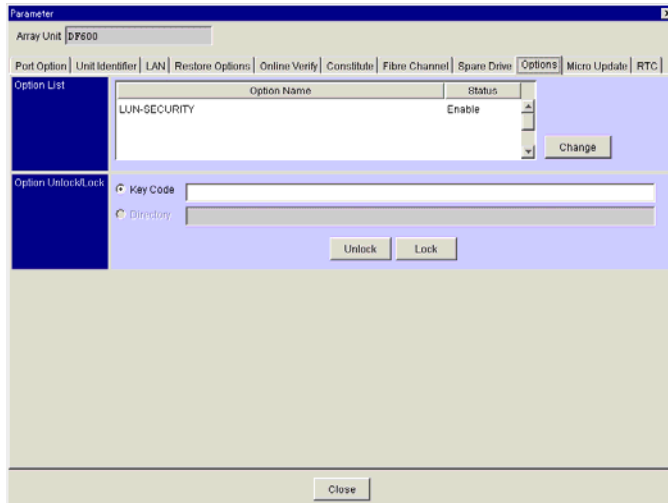



Figure 2.5 Parameter Panel (Options tab: unlocked: Enable)

2.2 Uninstalling SANTinel 9500V

The uninstall process for SANTinel 9500V requires the use of the key code provided with the optional feature.

To uninstall SANTinel 9500V using the GUI version of Resource Manager 9500V:

1. Start Resource Manager 9500V and change to **Management Mode**. For details, refer to the *Resource Manager 9500V User's Guide for GUI (MK-92DF605)*.
2. Register the array unit in which you will uninstall SANTinel 9500V. Connect to this array unit. The Array System Viewer Panel appears (refer to Figure 2.1).
3. From the **Settings** menu, select **Configuration Settings**. Alternatively, from the tool bar, select the **Configuration Settings**  button.
4. From the resulting Parameter panel, click the **Option** tab (refer to Figure 2.2).
5. Lock the optional features by using the following:
 - a) Enter a key code in the text box.
 - b) Click the **Lock** button.
6. A message appears, requesting a confirmation to lock the SANTinel 9500V feature. Click the **OK** button (see Figure 2.6).

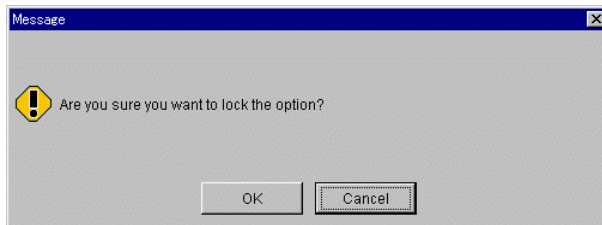

Figure 2.6 Lock Confirmation Request Message

7. A message appears, confirming that this optional feature is locked. Click the **OK** button (see Figure 2.7).

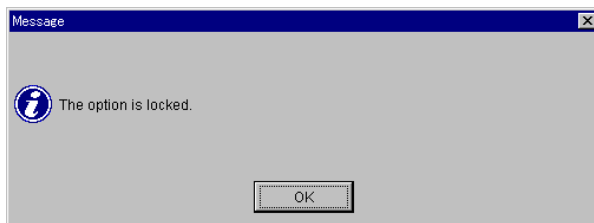

Figure 2.7 Locked Confirmation Message

The updated window appears (refer to Figure 2.2).

Chapter 3 Enabling or Disabling SANtinel 9500V (GUI)

To enable or disable SANtinel 9500V (without uninstalling this function) using the GUI version of Resource Manager 9500V:

1. Start the Resource Manager 9500V and change to **Management Mode**. For details, refer to the *Resource Manager 9500V User's Guide for GUI (MK-92DF605)*.
2. Register the array unit in which you will uninstall SANtinel 9500V. Connect to this array unit (for details, refer to *Resource Manager 9500V User's Guide for GUI (MK-92DF605)*).

The Array System Viewer panel appears and displays the connected array unit (see Figure 3.1).

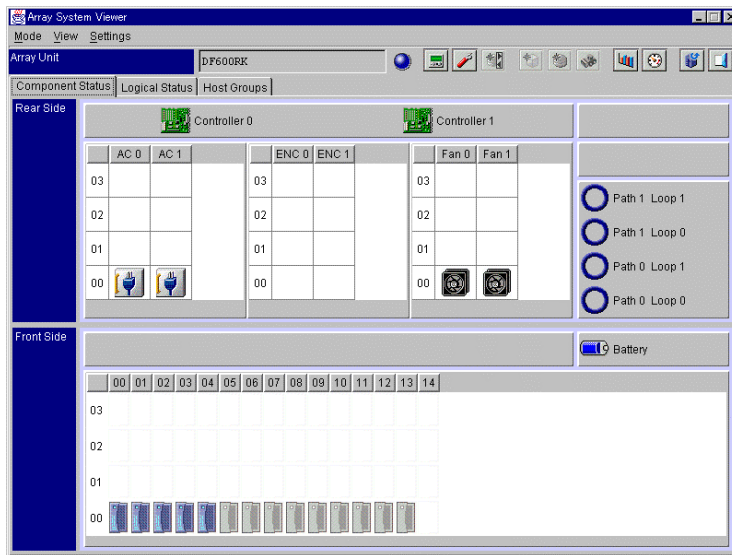



Figure 3.1 Array System Viewer Panel

3. From the **Settings** menu, select **Configuration Settings**. Alternatively, from the tool bar, select the **Configuration Settings**  button.
4. From the resulting Parameter panel, click the **Options** tab (see to Figure 3.2).

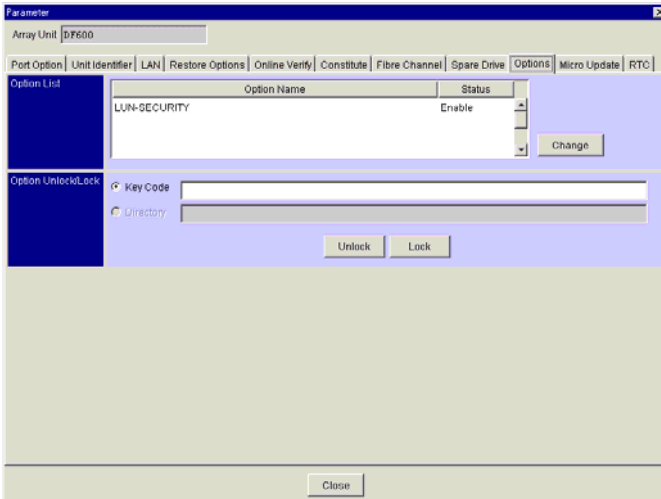

Figure 3.2 Parameter Panel (Options tab: No Option)

5. Click **LUN-SECURITY** in the **Option Name** text box, then click the **Change** button.
6. In the resulting message, click **OK** button (see Figure 3.3).

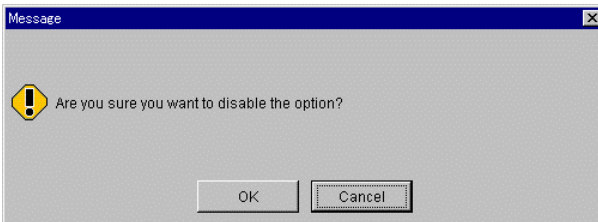

Figure 3.3 Enable/Disable Request Confirmation Message

7. A message appears, confirming that this option is set. Click the **OK** button (see Figure 3.4).



Figure 3.4 Confirmation Message

The updated window appears (see Figure 3.5).

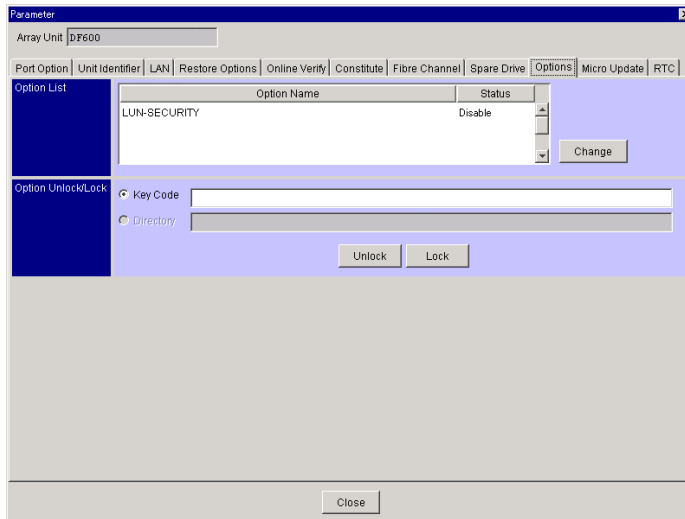

Figure 3.5 Option Verification

Note 1: This setting is not active until the host is rebooted. The subsystem cannot access the host until the reboot is completed and the host restarts. Therefore, be certain the host has stopped accessing data before starting the reboot process.

Note 2: Even when the SANtinel 9500V feature is disabled, the access check settings are valid.

Chapter 4 Browsing and Setting SANtinel 9500V Information (GUI)

When SANtinel 9500V information has been set, only specified hosts are allowed to access the selected LUNs. SANtinel 9500V information consists of the following:

- Host Identification Information
- Access Check Required Information
- Setting the Security Information
- Deleting the WWN of the Host HBA
- Deleting the WWN Accessible for Each LUN
- Changing the WWN of the Host HBA (Changing the WWN when the host is replaced)

4.1 Host Identification Information

Host identification specifies which hosts are allowed to access a selected LUN. This information contains three setting items per host for each. Up to 128 hosts can be specified.

1. Node name of host (mandatory)
2. Port name of host (mandatory)
3. LUN which allows the host to access (specified with internal LU, mandatory)

4.2 Access Check Required Information

This information specifies whether a selected LUN inhibits accessibility by hosts other than the specified host. By selecting Security Information Enable, a selected LUN inhibits accessibility by hosts other than the specified host. By not selecting Security Information Enable, a selected LUN can be accessed by all hosts, ignoring the host identification information.

The following list (see Table 4.1) indicates whether each setting item is set, browsed, and access-checked.

Table 4.1 Host Identification Item Status

No.	Host Identification Item	Setting	Browsing	Access-check
1	Host's node name	Enabled	Enabled	Not checked
2	Host's port name	Enabled	Enabled	Checked
3	LUN which allows the host to access	Enabled	Enabled	Checked

Host identification information and Access Check Necessity Information must be set for each port.

4.3 Setting the Security Information

Security information is set through the Resource Manager 9500V.

Note: Before setting the security information, you must install SANTinel 9500V and make its functions selectable (unlocked). For details, refer to Chapter 2 - Installing and Uninstalling SANTinel 9500V (GUI).

1. Start Resource Manager 9500V and change to **Management Mode**. For details, refer to the *Resource Manager 9500V User's Guide for GUI (MK-92DF605)*.
2. Register the array unit in which you will want to set SANTinel 9500V and connect to this array unit. The Array System Viewer panel appears (see Figure 4.1).

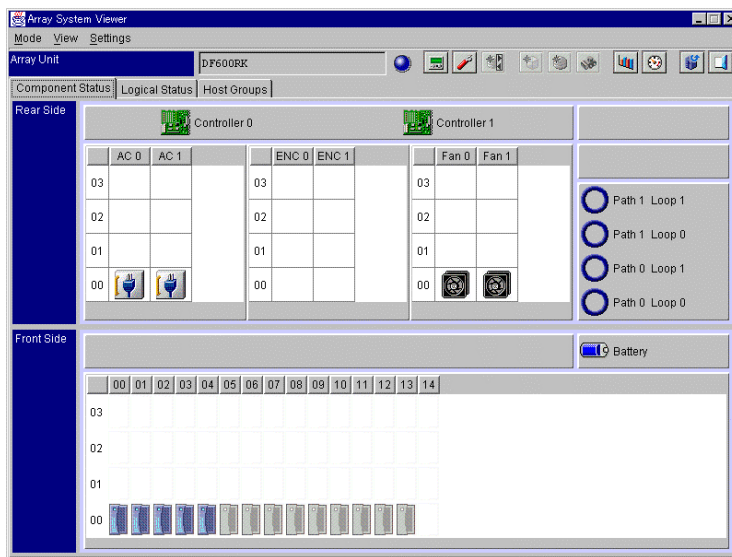

Figure 4.1 Array System Viewer Panel

3. Click the **Host Groups** tab and select the Port for which you want to set the security information.

4. From the **Settings** menu, select **Modify Security** (see Figure 4.2).

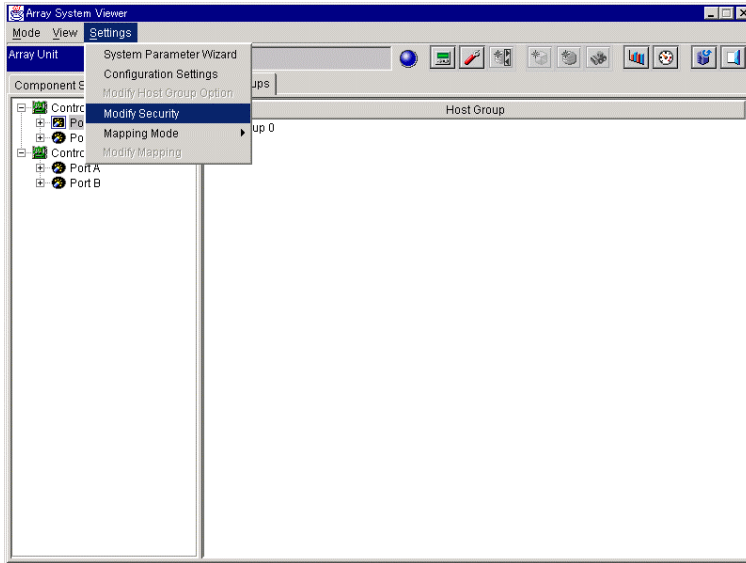

Figure 4.2 Array System Viewer Panel (Setting Security Information)

The Security Property panel appears (see Figure 4.3).

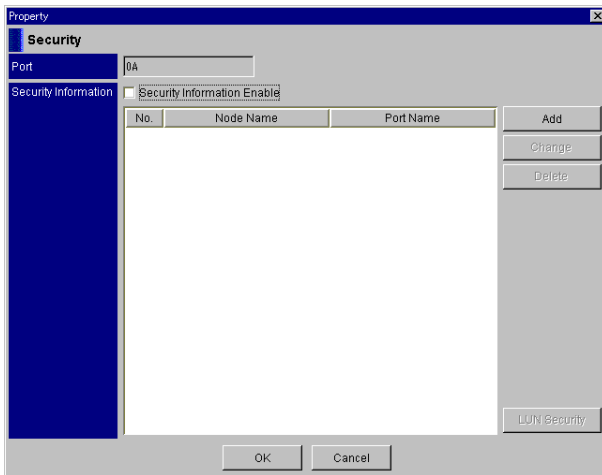

Figure 4.3 Security Property Panel

5. Click **Add** button. The WWN dialog appears (see Figure 4.4).

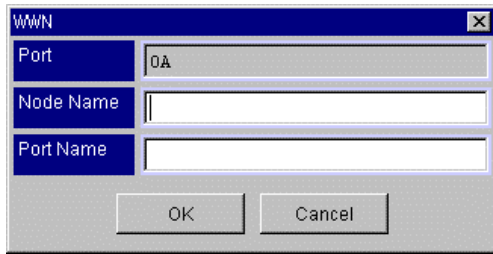

Figure 4.4 WWN Dialog Box

6. Enter the **Node Name** (16 hexadecimal digits) and **Port Name** (16 hexadecimal digits) of the host WWN. Click the **OK** button (see Figure 4.5).

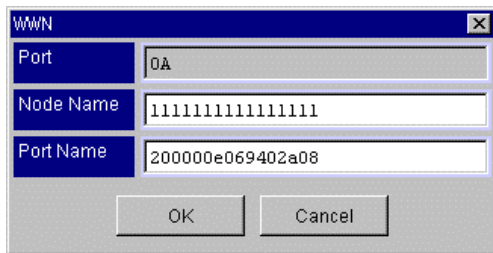

Figure 4.5 Node Name Entry

The added WWN appears in the Security property field (see Figure 4.3).

7. In the Security panel (refer to Figure 4.3), click the **Security Information Enable** check box and then the **SANTinel (LUN Security)** button. The SANTinel (LUN Security) panel appears (see Figure 4.6).

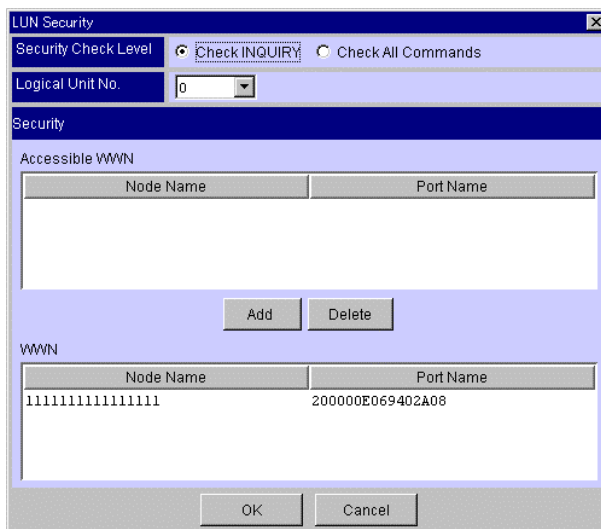

Figure 4.6 LUN Security Panel (Selecting Security Check Level, Logical Unit No., and Node Name)

8. Select **Security Check Level** and **Logical Unit No.** from the Logical Unit No. drop-down list. Select the **Node Name** from the Node Name list. Click the **Add** button.

9. Click the **OK** button.

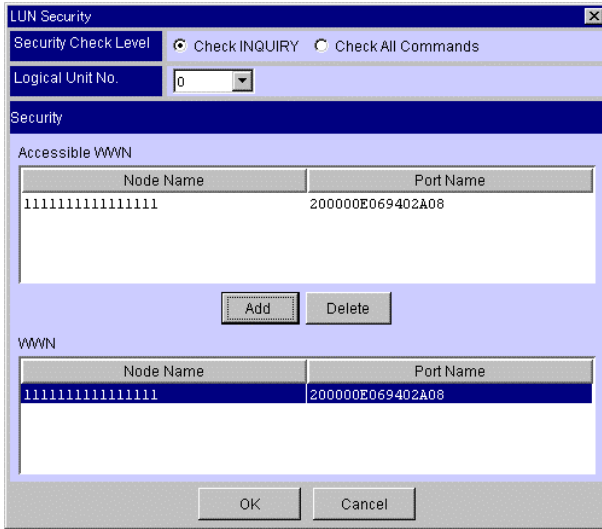

Figure 4.7 LUN Security Panel (Selecting Security Check Level and Logical Unit)

10. In the SANTinel (Security Property) panel, click the **OK** button. The following message appears (see Figure 4.8).

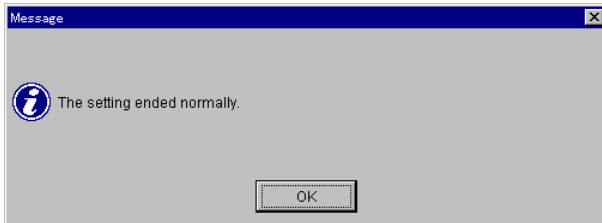

Figure 4.8 Setting Ended Confirmation Message

11. Click the **OK** button. This completes the security information setting procedure.

12. Write down the security information on the following form (see Figure 4.9) and update it when changes are made.

4.4 Deleting the WWN of the Host HBA

To delete the WWN information of the host HBA using Resource Manager 9500V:

1. Start Resource Manager 9500V and change to **Management Mode**. For details, refer to the *Resource Manager 9500V User's Guide for GUI (MK-92DF605)*.
2. Register the array unit in which you want to delete SANTinel 9500V and connect to this array unit. The Array System Viewer panel appears (refer to Figure 4.1).
3. Click the **Host Groups** tab, and select the Port from which you want to delete the WWN Information.
4. From the **Settings** menu of the Array System Viewer panel, select **Modify Security** (refer to Figure 4.10).
5. Click the security **No.** to delete the security information among those ports displayed in the **Security Information** box. Click the **Delete** button (see Figure 4.10).

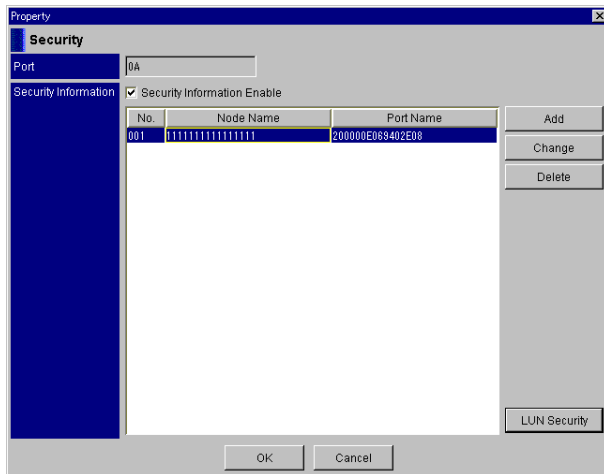

Figure 4.10 Security Property Panel (Delete the WWN of the Host HBA)

6. Click the **OK** button. A message appears (refer to Figure 4.8).
7. Click the **OK** button. This completes the security information deletion procedure.

4.5 Deleting the WWN Accessible for Each LUN

To delete the WWN information accessible for each LUN using Resource Manager 9500V:

1. Start Resource Manager 9500V and change to **Management Mode**. For details, refer to the *Resource Manager 9500V User's Guide for GUI (MK-92DF605)*.
2. Register the array unit in which you want to delete SANTinel 9500V and connect to this array unit. The Array System Viewer panel appears (refer to Figure 4.1).
3. Click the **Host Groups** tab, and select the Port from which you want to delete the WWN Information.
4. From the **Settings** menu of the Array System Viewer panel, select **Modify Security** (refer to Figure 4.2).
5. Click the security **No.** to delete the security information among those ports displayed in the **Security Information** box. Click the **SANTinel (LUN Security)** button.
6. Click **WWN** to delete from the **Accessible WWN** box. Click the **Delete** button.

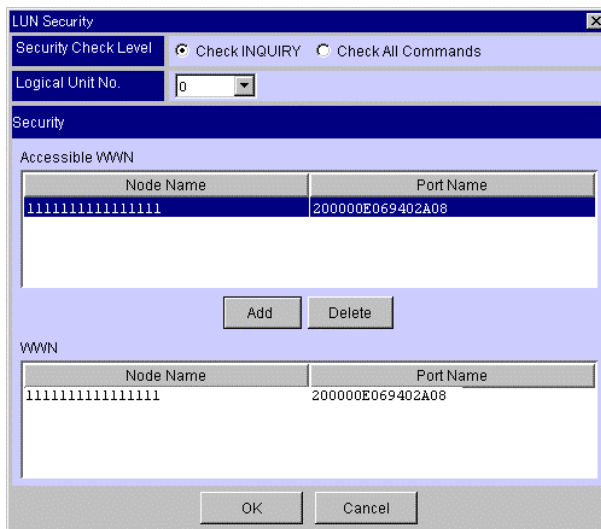

Figure 4.11 Selecting the WWN to Delete

7. Click the **OK** button on the SANTinel (LUN Security) panel.
8. Click the **OK** button on the Security Property panel. A message appears (refer to Figure 4.8).
9. Click the **OK** button. This completes the security information deletion procedure.

4.6 Changing the WWN of the Host HBA (Changing the WWN when the host HBA is replaced)

To change the WWN of the host HBA with Resource Manager 9500V:

Note: Perform this operation when the host HBA is replaced.

1. Start Resource Manager 9500V and change to **Management Mode**. For details, refer to the *Resource Manager 9500V User's Guide for GUI (MK-92DF605)*.
2. Register the array unit in which you want to change SANtinel 9500V and connect to this array unit. The Array System Viewer panel appears (refer to Figure 4.1).
3. Click the **Host Groups** tab, and select the Port for which you want to change the WWN Information.
4. From the **Settings** menu of the Array System Viewer panel, select **Modify Security** (refer to Figure 4.2).
5. Click the change the security information about the ports in the **Security Information** box. Click the **Change** button.
6. In the resulting WWN dialog box, enter the **Node Name** and the **Port Name** of the host's WWN (see Figure 4.12). Click the **OK** button. **Node Name** and **Port Name** are 16 hexadecimal digits.

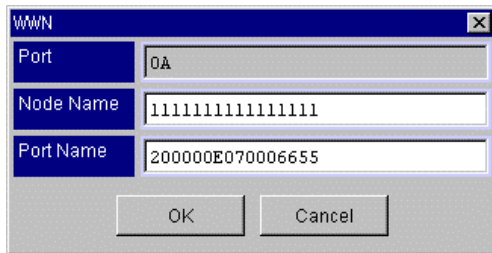

Figure 4.12 WWN Dialog Box

7. Click the **OK** button. A message appears (refer to Figure 4.8).
8. Click the **OK** button. This completes the security information change procedure.

Chapter 5 Troubleshooting

5.1 Troubleshooting

The 9500V subsystem provides continuous data availability and is not expected to fail in any way that would interrupt access to user data. For troubleshooting information on the 9500V subsystem or Resource Manager, please refer to the 9500V User and *Reference Manual* (MK-92DF601), the *Resource Manager 9500V User's Guide for GUI* (MK-92DF605), or the *Resource Manager 9500V User's Guide for CLI* (MK-92DF603).

5.2 Calling the Hitachi Data Systems Technical Support Center

If you need to call the Hitachi Data Systems Technical Support Center, be sure to provide as much information about the problem as possible. Include the circumstances surrounding the error or failure and the exact content of any error codes and/or messages displayed. The worldwide Hitachi Data Systems Technical Support Centers are:

- Hitachi Data Systems North America/Latin America
San Diego, California, USA
1-800-348-4357
- Hitachi Data Systems Europe
Contact Hitachi Data Systems Local Support
- Hitachi Data Systems Asia Pacific
North Ryde, Australia
011-61-2-9325-3300

Appendix A SANtinel Operations Using CLI

This section includes the following:

- Installing SANtinel 9500V
- Uninstalling SANtinel 9500V
- Enabling or Disabling SANtinel 9500V
- Browsing and Setting SANtinel 9500V Information

A.1 Installing SANtinel 9500V

The SANtinel 9500V feature is usually unselectable (locked). To make this feature available, you must install SANtinel 9500V and make its functions selectable (unlocked). To install this function, use the key code provided with the optional feature.

SANtinel 9500V is installed and uninstalled through the Resource Manager 9500V.

Note: Before installing and uninstalling, make sure that the array unit is in normal operating mode. If a failure such as a controller blockade has occurred, installation and uninstallation operations cannot be performed.

To install SANtinel 9500V using the CLI version of Resource Manager 9500V:

1. From the command prompt, register the subsystem (array unit) in which you will install SANtinel 9500V and connect to the subsystem (for details, refer to *Resource Manager 9500V User's Guide for CLI (MK-92DF603)*).
2. Unlock the optional features by using either of the following:

Example 1:

```
% auopt -unit df600 -lock off -keycode Key code
Password:
Option was opened.
%
```

Example 2:

```
% auopt -unit df600 -refer
Password:
Option name      Status
LUN-SECURITY    Enable
%
```

A.2 Uninstalling SANTinel 9500V

To uninstall SANTinel 9500V, use the key code provided with the optional feature.

SANTinel 9500V is installed and uninstalled through the Resource Manager 9500V.

To uninstall SANTinel 9500V using the CLI version of Resource Manager 9500V:

1. From the command prompt, register the subsystem (array unit) in which you will uninstall SANTinel 9500V and connect to the subsystem (for details, refer to *Resource Manager 9500V User's Guide for CLI (MK-92DF603)*).
2. Lock the optional features by using the following:

Example 1:

```
% auopt -unit df600 -lock on -keycode Key code
Password:
Option was closed.
%
```

Example 2:

```
% auopt -unit df600 -refer
Password:
DMEC002015:No information displayed.
%
```

A.3 Enabling or Disabling SANtinel 9500V

To enable or disable SANtinel 9500V (without uninstalling this function) using the CLI version of Resource Manager 9500V:

1. From the command prompt, register the subsystem (array unit) in which you will change the status of the SANtinel feature and connect to the subsystem (for details, refer to *Resource Manager 9500V User's Guide for CLI (MK-92DF603)*).
2. Execute the **auopt** command to change the status (enable or disable) of the SANtinel feature.

The following is an example of how to change the status from enable to disable. To change the status from disable to enable, enter enable after the -st option.

Example 1:

```
% auopt -unit df600 -option LUN-SECURITY -st disable
Password:
Option setting ended normally.
%
```

Example 2:

```
% auopt -unit df600 -refer
Password:
Option name      Status
LUN-SECURITY    Disable
%
```

Note 1: This setting is not active until the host is rebooted. The subsystem cannot access the host until the reboot is completed and the host restarts. Therefore, be certain the host has stopped accessing data before starting the reboot process.

Note 2: Even when the SANtinel 9500V feature is disabled, the access check settings are valid.

A.4 Browsing and Setting SANtinel 9500V Information

When SANtinel 9500V information has been set, only specified hosts are allowed to access the selected LUNs. SANtinel 9500V information consists of the following:

- Host Identification Information
- Access Check Required Information
- Setting the Security Information
- Deleting the WWN of the Host HBA
- Deleting the WWN Accessible for Each LUN
- Changing the WWN of the Host HBA (Changing the WWN when the host is replaced)

A.4.1 Host Identification Information

Host identification information specifies which hosts are allowed to access a selected LUN. This information contains four setting items per host for each. Up to 128 hosts can be designated.

- Host Node Name (mandatory)
- Host Port Name (mandatory)
- LUN which allows the host access (specified with internal LU; mandatory)

A.4.2 Access Check Necessity Information

The access check necessity information specifies whether a selected LUN inhibits access by a host other than the specified host. When the `-lus` setting is on, a selected LUN inhibits access by any host other than the specified host. When the `-lus` setting is off, all hosts can access a selected LUN; host identification information is ignored.

Table A.1 lists the status of each host identification item:

Table A.1 Host Identification Item Status

No.	Host identification item	Setting	Browsing	Access-check
1	Host's node name	Enabled	Enabled	Not checked
2	Host's port name	Enabled	Enabled	Checked
3	LUN which allows the host to access	Enabled	Enabled	Checked

Note: Host identification information and Access Check Necessity Information must be set for each port.

A.4.3 Setting the Security Information

Security information is set through the Resource Manager 9500V.

Note: Before setting the security information, you must install SANTinel 9500V and make its functions selectable (unlocked).

1. From the command prompt, register the subsystem (array unit) in which you want to set the security information and connect to the subsystem (for details, refer to *Resource Manager 9500V User's Guide for CLI* (MK-92DF603)).
2. Execute the `auhgwwn` command to specify the subsystem.
3. Use the following settings:
 - Subsystem name: df600
 - Controller: 0
 - Port: A
 - Host information (node name and port name): 1111111111111111 and 20000e069402a08

Example:

```
% auhgwwn -unit df600 -set -lus 0 A on -perm 0 A 1111111111111111 20000e069402a08
Password:
This security information has been set successfully.
%
```

4. Specify as shown below when the checking information has been set:

Example:

```
% auhgwwn -unit df600 -refer
Password:
Security Information
Port    LUN Security    Node name          Port name
0A      on              1111111111111111 20000E069402A08
0B      off
1A      off
1B      off
%
```

5. Write down the security information on the following form (see Figure A.1) and update it when changes are made.

A.4.4 Deleting the WWN of the Host HBA

To delete the WWN information of the host HBA using Resource Manager 9500V:

1. From the command prompt, register the subsystem (array unit) in which you want to set the security information and connect to the subsystem (for details, refer to *Resource Manager 9500V User's Guide for CLI (MK-92DF603)*).
2. Execute the `auhgwwn` command to specify the subsystem.
3. Set as shown, when the following information needs to be deleted:
 - Subsystem name: df600
 - Controller: 0
 - Port: A
 - Host information (node name and port name): 1111111111111111 and 200000e069402a08

Example:

```
% auhgwwn -unit df600 -rm -perm 0 A 1111111111111111 200000e069402a08
Password:
This security information has been set successfully.
%
```

4. Specify as shown when setting the following information:

Example:

```
% auhgwwn -unit df600 -refer
Password:
Security Information
Port LUN Security Node name Port name
0A off
0B off
1A off
1B off
%
```

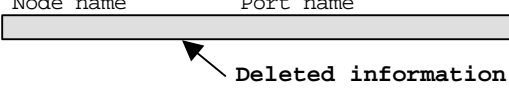

A.4.5 Deleting the WWN Accessible for Each LUN

This procedure is identical to the procedure for deleting the WWN of the Host HBA in section A.4.4.

A.4.6 Changing the WWN of the Host HBA (Changing the WWN when the host HBA is replaced)

This procedure is identical to the procedure for Setting the Security Information in section A.4.3.

The following is an example in which SANTinel was validated and the host WWN was specified as LU 0.

Example:

Security Information			
Port	LUN Security	Node name	Port name
0A	on (INQUIRY)	1111111111111111	200000E069402A080
0B	off		
1A	off		
1B	off		

Appendix B Using the WWN Change Operation when the HBA is Replaced

When you replace the HBA of the host (server) using SANTinel 9500V, you need to change the WWN setting of SANTinel 9500V. This section includes the following information:

- WWN Change Procedure when the HBA is Replaced
- Obtaining the WWN of a Host

B.1 WWN Change Procedure when the HBA is Replaced

Follow these steps:

1. Check the WWN before and after HBA replacement. For the WWN after HBA replacement, see *Obtaining the WWN of a Host* in section B.2.
2. Change the WWN before HBA replacement to the WWN after HBA replacement by the following SANTinel 9500V setting procedure.

When changing the setting, refer to *Changing the WWN of the Host HBA (Changing the WWN when the host HBA is replaced)* in section A.4.6.

3. Restart the host with the replaced HBA. Verify that the LU was recognized; this must occur before HBA replacement can be recognized after the HBA replacement. When the LU is not recognized, SANTinel 9500V is not correctly set. Use the procedures from step 2 above to set the WWN again.

B.2 Obtaining the WWN of a Host

The node name, port name, and N_port ID of a host (which is required as host identification information) can be obtained using the host console.

This section explains how to obtain the WWN of a host on the following systems:

- Solaris™
- HP®
- IBM®
- SGI™
- Windows NT®/Windows® 2000

B.2.1 Solaris™

There are two methods for obtaining the WWN of a host:

Method 1:

To obtain the WWN of a host when the HBA is a JNI FC64-1063 or FCI-1063 (driver version: HIT.06.01 earlier):

1. Execute the following command to obtain the WWN of the HBA.

```
# dmesg      ← Command name
:
Ethernet address = 8:0:20:89:b:7
root nexus = Sun Ultra 2 UPA/SBus (UltraSPARC-II 296MHz)
sbus0 at root: UPA 0x1f 0x0 ...
fas0: rev 2.2 FEPS chipSUNW,fas0 at sbus0: SBus0 slot 0xe offset 0x8800000 and slot
0xe offset 0x8810000 Onboard device sparc9 ipl 4
sd0 at SUNW,fas0: target 0 lun 0
sd0 is /sbus@1f,0/SUNW,fas@e,8800000/sd@0,0
      <SUN4.2G cyl 3880 alt 2 hd 16 sec 135>
sd6 at SUNW,fas0: target 6 lun 0
sd6 is /sbus@1f,0/SUNW,fas@e,8800000/sd@6,0
fcaw0: Host: Port 000001 (WWN 200000e0694005e5)
fcaw0: JNI Fibre Channel Adapter model FCW
fcaw0: 64-bit SBus 1: IRQ 3: FCODE Version 12 [alf55]
fcaw0: Fibre Channel WWN: 200000e0694005e5
fcaw0: FCA Driver Version 2.2.0.HIT.03, Feb 04, 1999 for Solaris 2.6
fcaw0: All Rights Reserved.
fcaw0: < Total IOPB space used: 1140160 bytes >
fcaw0: < Total DMA space used: 4235293 bytes >
fcaw0: < DMA redzone len 224 bytes >
fcaw1: Host: Port 000001 (WWN 200000e0694005f6)
fcaw1: JNI Fibre Channel Adapter model FCW
fcaw1: 64-bit SBus 3: IRQ 3: FCODE Version 12 [alf55]
fcaw1: Fibre Channel WWN: 200000e0694005f6
fcaw1: FCA Driver Version 2.2.0.HIT.03, Feb 04, 1999 for Solaris 2.6
fcaw1: All Rights Reserved.
fcaw1: < Total IOPB space used: 1140160 bytes >
fcaw1: < Total DMA space used: 4235293 bytes >
```

2. Read and record the port name and the N_Port ID. The node name can be obtained from the port name. Replace the value "20" of the highest one byte of the port name (200000e069xxxxx) with "10".

Example:

Port name: 200000e0694005e5
 ↓
Node name: 100000e0694005e5

When the JNI HBA is FC64-1063 or FCI-1063 (driver version: HIT.06 later), or FCE-1063, FCE-6410, FCE-6460, FCE-1473, FCC-6460, the system parameters of the subsystem must be changed.

1. Execute the following command to obtain the file name of the HBA.

Example:

```

E250-1# luxadm inq /dev/rdisk/c3t0d0s2 ←Command name

INQUIRY:
  Physical Path:
    /devices/pci@1f,4000/fibre-channel@4/sd@0,0:c,raw
Vendor:          HITACHI
Product:         DF400
Revision:
Device type:     0x0 (Disk device)
Removable media: no
ISO version:     0
ECMA version:    0
ANSI version:    2 (Device complies to ANSI X3.131-1994 (SCSI-2))
Response data format: 2
Additional length: 0x73
      VENDOR-SPECIFIC PARAMETERS
Byte#           Hex Value                               ASCII
36  44 35 30 4c 30 30 42 41 30 30 30 30 00 31 41 00    D50L00BA0000.1A.
    00 01 00 00
96  00 00 05 00 00 00 ff 00 10 00 00 00 0e 24 90 74    .....$.t
    10 00 08 00 20 b0 19 a8                               .....

```

Node Name

2. Refer to the node name shown in the previous output example. The port name can be obtained from the node name. When the node name is 100000000e249074, the port name is obtained through replacement of the top byte, that is, 10 with 20. Therefore, the port name turns out to be 200000000e249074.

Example:

```

Node name:   100000000e249074
             ↓
Port name:   200000000e249074

```

Determining an HBA Location:

The WWN can be obtained from the label on the side of the JNI HBA.

B.2.2 HP®

To obtain the WWN of a host when the original HP® HBA is A3404A, A3740A, A5158A, A6684A, A6685A, or A6795A:

1. Execute the following command to obtain the file name of the HBA.

Example:

```
# iocscan -nfc fc
Class  I H/W Path Driver S/W State H/W Type Description
=====
fc    0 0/4/0/0 fcT1 UNCLAIMED UNKNOWN PCI SerialBus (107e0004)
fc    1 0/5/0/0 fcT1 UNCLAIMED UNKNOWN PCI SerialBus (107e0004)
fc    2 0/8/0/0 td CLAIMED INTERFACE HP Tachyon TL/TS Fibre Channel Mass S
storage Adapter
      /dev/td2 _____ Device file Name
fc    3 0/12/0/0 td CLAIMED INTERFACE HP Tachyon TL/TS Fibre Channel Mass S
storage Adapter
      /dev/td3 _____ Device file Name
fc    4 1/10/0/0 fcT1 UNCLAIMED UNKNOWN PCI SerialBus (107e0004)
fc    5 1/12/0/0 fcT1 UNCLAIMED UNKNOWN PCI SerialBus (107e0004)
```

2. Refer to the Device file name shown in the output example above. In this example, the device file names are: /dev/td2 and /dev/td3.
3. Using the device file names shown above, execute the command shown below to obtain the WWN of the HBA.

Example:

```
# fmsutil /dev/td3
Vendor ID is = 0x00103c
Device ID is = 0x001028
TL Chip Revision No is = 2.3
PCI Sub-system Vendor ID is = 0x00103c
PCI Sub-system ID is = 0x000006
Previous Topology = PTTOPT_FABRIC
Local N_Port_id is = 0x011600
N_Port Node World Wide Name = 0x50060b000008829f
N_Port Port World Wide Name = 0x50060b000008829e
Driver state = AWAITING_LINK_UP
Hardware Path is = 0/12/0/0
Number of Assisted IOs = 504123690
Number of Active Login Sessions = 0
```

4. Refer to the node name and port name shown in the example above.

Determining an HBA Location:

When HP-UX® is running in HP9000, you may not be able to match the HBA with the WWN because there is no way to identify the HBA address based on the slot location. In this case, correlate the HBA with a WWN using the following procedure:

1. Connect the host and the subsystem. Start the system.
2. Execute the following command to obtain the device file name of the HBA.

Example:

```
# ioscscan -nfc fc
Class  I H/W Path Driver S/W State H/W Type Description
=====
fc 0 0/4/0/0 fcT1 UNCLAIMED UNKNOWN PCI SerialBus (107e0004)
fc 1 0/5/0/0 fcT1 UNCLAIMED UNKNOWN PCI SerialBus (107e0004)
fc 2 0/8/0/0 td CLAIMED INTERFACE HP Tachyon TL/TS Fibre Channel Mass S
storage Adapter
      /dev/td2      Address of /dev/td2      Device file Name
fc 3 0/12/0/0 td CLAIMED INTERFACE HP Tachyon TL/TS Fibre Channel Mass S
storage Adapter
      /dev/td3      Address of /dev/td3      Device file Name
fc 4 0/10/0/0 fcT1 UNCLAIMED UNKNOWN PCI SerialBus (107e0004)
fc 5 0/12/0/0 fcT1 UNCLAIMED UNKNOWN PCI SerialBus (107e0004)
```

3. Disconnect the fibre channel cable of the HBA of the WWN that you wish to identify.
4. Determine which disk is currently connected and its correspondence with the device file of the HBA.

Example:

```
# ioscan -nfc disk
Class  I H/W Path      Driver  S/W State  H/W Type  Description
=====
disk   0 0/0/1/0.2.0    sdisk   CLAIMED   DEVICE    HP      DVD-ROM 6x/32x
        /dev/dsk/c0t2d0 /dev/rdisk/c0t2d0
disk   1 0/0/2/0.6.0    sdisk   CLAIMED   DEVICE    SEAGATE ST39102LC
        /dev/dsk/c1t6d0 /dev/rdisk/c1t6d0
disk   2 0/0/2/1.6.0    sdisk   CLAIMED   DEVICE    SEAGATE ST39103LC
        /dev/dsk/c2t6d0 /dev/rdisk/c2t6d0
disk  169 0/8/0/0.1.19.232.0.0.0 sdisk   CLAIMED   DEVICE    HITACHI DF500F
        /dev/dsk/c19t0d0 /dev/rdisk/c19t0d0
disk  170 0/8/0/0.1.19.232.0.0.1 sdisk   CLAIMED   DEVICE    HITACHI DF500F
        /dev/dsk/c19t0d1 /dev/rdisk/c19t0d1
:
disk  141 0/12/0/0.1.19.228.0.0.0 sdisk   NO_HW     DEVICE    HITACHI DF500F
        /dev/dsk/c21t0d0 /dev/rdisk/c21t0d0
disk  297 0/12/0/0.1.19.228.0.0.1 sdisk   NO_HW     DEVICE    HITACHI DF500F
        /dev/dsk/c21t0d1 /dev/rdisk/c21t0d1
:
```

As indicated in the above example, the disks identified as NO-HW are not connected. According to this information and the address of the device file of the HBA, the device file name of the HBA, whose cable has been disconnected, is: /dev/td3.

Execute the **fcmsutil** to obtain the WWN of the /dev/td3.

5. Plug in the disconnected fibre channel.

B.2.3 IBM®

To obtain the WWN of a host when the original IBM is FC6227 or FC6228:

1. Execute the following command to obtain the device file name of the HBA.

Example:

```
# lsparent -C -k iocb
  fcs0 Available 27-08 FC Adapter ← Device file name
  fcs1 Available 3A-08 FC Adapter
  fcs2 Available 31-08 FC Adapter
  fcs3 Available 34-08 FC Adapter
```

2. Refer to the Device file name shown in the example above. In this example, the device file names are: fcs0, fcs1, fcs2, and fcs3.
3. Using the device file names given in the previous example, execute the following example to obtain the WWN of the HBA.

Example:

```
# lscfg -vl fcs0
DEVICE          LOCATION      DESCRIPTION
fcs0            27-08        FC Adapter
                Part Number.....09P1162
                EC Level.....D
                Serial Number.....KT04904230
                Manufacturer.....0010
                FRU Number.....09P1173
                Network Address.....10000000C925437E ← Port name
                ROS Level and ID.....02903290
                Device Specific.(Z0).....4002206D
                Device Specific.(Z1).....10020193
                Device Specific.(Z2).....3001506D
                Device Specific.(Z3).....02000909
                Device Specific.(Z4).....FF101450
                Device Specific.(Z5).....02903290
                Device Specific.(Z6).....06113290
                Device Specific.(Z7).....07113290
                Device Specific.(Z8).....20000000C925437E
                Device Specific.(Z9).....SS3.22A0
                Device Specific.(ZA).....S1F3.22A0
                Device Specific.(ZB).....S2F3.22A0
                Device Specific.(YL).....P1-I8/Q1
```

The value shown in the Network Address section in the output example above is the port name.

Determining an HBA Location:

A label with the WWN is adhered on the genuine IBM HBA; identify the WWN.

B.2.4 SGI™

To obtain the WWN of a host when the genuine SGI™ is XT-FV-1PORT:

1. Execute the following command to obtain the WWN of the HBA.

Example:

```
origin2002 1# scsiha -w 2
2 Portname: 210000e08b01cb83 ← Port Name of the Slot 2

origin2002 2# scsiha -w 8
8 Portname: 210000e08b01fe64 ← Port Name of the Slot 8

origin2002 3# scsiha -w 11
11 Portname: 210000e08b01f454 ← Port Name of the Slot 11
```

2. Refer to the port name shown in the output example above.

Determining an HBA Location:

The location and arrangement of slots vary, depending on the model of SGI™ server. However, you match the HBA and WWN by referring to the slot location of each model.

B.2.5 Windows NT®/ Windows® 2000

There are two methods for obtaining the WWN of a host:

- Emulex Port Driver/SCSI Miniport Driver
- Qlogic QLA2200F/QLA2300F

B.2.5.1 Emulex Port Driver

When the Emulex driver is installed on the host, the Emulex Configuration Tool (elxcfg.exe) is installed on Windows NT®/Windows® 2000. Run the Emulex Configuration Tool to obtain the WWN of the host. Follow these steps:

1. Start the elxcfg.exe.
2. Double-click HBA to obtain the WWN on the Available Adapter list. (Adapters corresponding to the number of installed HBAs are displayed.)
3. The Port WWN (Port Name) and Node WWN (Node Name) are displayed in the Adapter Information screen.
4. When two or more HBAs are installed, repeat Steps 2 through 3 above.

B.2.5.2 EmulexSCSI Miniport Driver

When the Emulex driver is installed on the host, the LightPulse Utility/NT (lputilnt.exe) utility is installed on Windows NT®/Windows® 2000. Run the LightPulse Utility/NT utility to obtain the WWN of the host. Follow these steps:

1. Start the **lputilnt.exe**.
2. Select **Adapter X** on the display. (Adapters corresponding to the number of installed HBAs are displayed.)
3. Select **Adapter Revision Levels** on the Category menu.
4. IEEE Address XX-XX-XX-XX-XX-XX (6 bytes) appears on the bottom of the screen.
5. Place **10-00** before the IEEE Address XX-XX-XX-XX-XX-XX. This is a port name.

Example:

10-00-XX-XX-XX-XX-XX-XX

6. The node name is equal to the port name.
7. The N_Port ID is omitted.
8. When two or more HBAs are installed, repeat Steps 2 through 7 above.

Note: The LightPulse Utility/NT utility is supported by the Emulex driver of version 4.2 or later. If the version is earlier than 4.2, check the IEEE Address by the label on the board.

B.2.5.3 Qlogic QLA2200F/QLA2300F

To obtain the WWN of a host on the Windows NT® (Qlogic2200F), follow these steps:

1. When the host starts up or when the QLA2xxx board is initialized for rebooting, the message: Press<ALT-Q> for Fast!UTIL appears. Press the **Q** key while holding down the **ALT** key. The Qlogic Fast!UTIL utility starts.
2. Select an adapter corresponding to the HBA. (Adapters corresponding to the number of installed HBAs are displayed.)
3. Select Configuration Settings from the **Fast!UTIL** option and press the **Enter** key.
4. Select Host Adapter Settings from **Configuration Setting** and press the **Enter** key.
5. Read the value in the Adapter Node Name field on the Host Adapter Settings window. This contains the node name and the port name of the host (set for security).
6. When two or more HBAs are installed, repeat Steps 2 through 5 above.

Example:

```
Qlogic Fast!UTIL Version x. xx

Select Adapter(Example)
Adapter Type    I/O Address
WLA2xxx        F800

Host Adapter Settings(Example)
BIOS Address    : D8000
BIOS Revision   : 1.28
Adapter Serial Number : A26181
Interrupt Level : 5
Adapter Node Name : 200000E0 8B00 4566
.
.
.
```

node name and port name

Acronyms and Abbreviations

DAMP	disk array manager program (now called Resource Manager)
FDD	floppy disk drive
HBA	host bus adapter
LU	logical unit
LUN	logical unit number
OS	operating system
Resource Manager	formerly referred to as disk array manager program
SAN	storage-area network
WWN	world wide name

Index

A

- access check required
 - enabling/disabling
 - using CLI, 28
 - using GUI, 14

B

- browsing/setting Security Information
 - using CLI, 28
 - using GUI, 13

C

- changing
 - host HBA WWN
 - using CLI, 32
 - using GUI, 22
 - WWN when HBA replaced
 - using CLI, 33

D

- deleting
 - host HBA WWN
 - using CLI, 31
 - using GUI, 20
 - WWN accessible
 - using CLI, 31
 - using GUI, 21
- determining HBA location
 - for HP®, 37
 - for IBM®, 39
 - for SGI™, 40

E

- enabling/disabling access check required
 - using CLI, 28
 - using GUI, 14
- enabling/disabling SANTinel 9500V
 - using CLI, 27
 - using GUI, 9

F

- functions of SANTinel 9500l, 1

H

- host HBA WWN
 - changing
 - using GUI, 22
 - deleting
 - using CLI, 31
 - using GUI, 20

- host ID information
 - setting
 - using CLI, 28
 - using GUI, 13

I

- installing SANTinel 9500V
 - using CLI, 25
 - using GUI, 5

K

- Key Code
 - uninstalling SANTinel 9500V
 - using GUI, 8

L

- LightPulse/NT utility
 - running, 42
- locking SANTinel 9500V
 - using GUI
 - using Key Code, 8

O

- obtaining host WWN
 - for HP®, 36
 - for IBM®, 39
 - for SGI™, 40
 - for Solaris™, 34
 - for Windows NT®/Windows® 2000, 41
- overview
 - SANTinel 9500, 1

R

- running
 - lputilnt utility, 43
 - LightPulse/NT utility, 42

S

- Security Informaiton
 - browsing/setting
 - using CLI, 28
 - using GUI, 13
 - security information
 - setting using CLI, 29
 - setting using GUI, 15
 - security information list, 19, 30

setting

- access check required

 - using CLI, 28

 - using GUI, 14

- host ID information

 - using CLI, 28

 - using GUI, 13

- SANTinel information, 3

- security information

 - using CLI, 29

 - using GUI, 15

- specifications of SANTinel 9500, 2

T

- technical support, 23

- troubleshooting, 23

U

- uninstalling SANTinel 9500V

 - using CLI, 26

 - using GUI, 8

 - using Key Code, 8

W

- WWN accessible

 - deleting

 - using CLI, 31

 - using GUI, 21